

IP2368EN • 2020-07-15

## Ditec LCA70

Control panel installation manual for automations with one or two 230V~ motors

(translation of the original instructions)

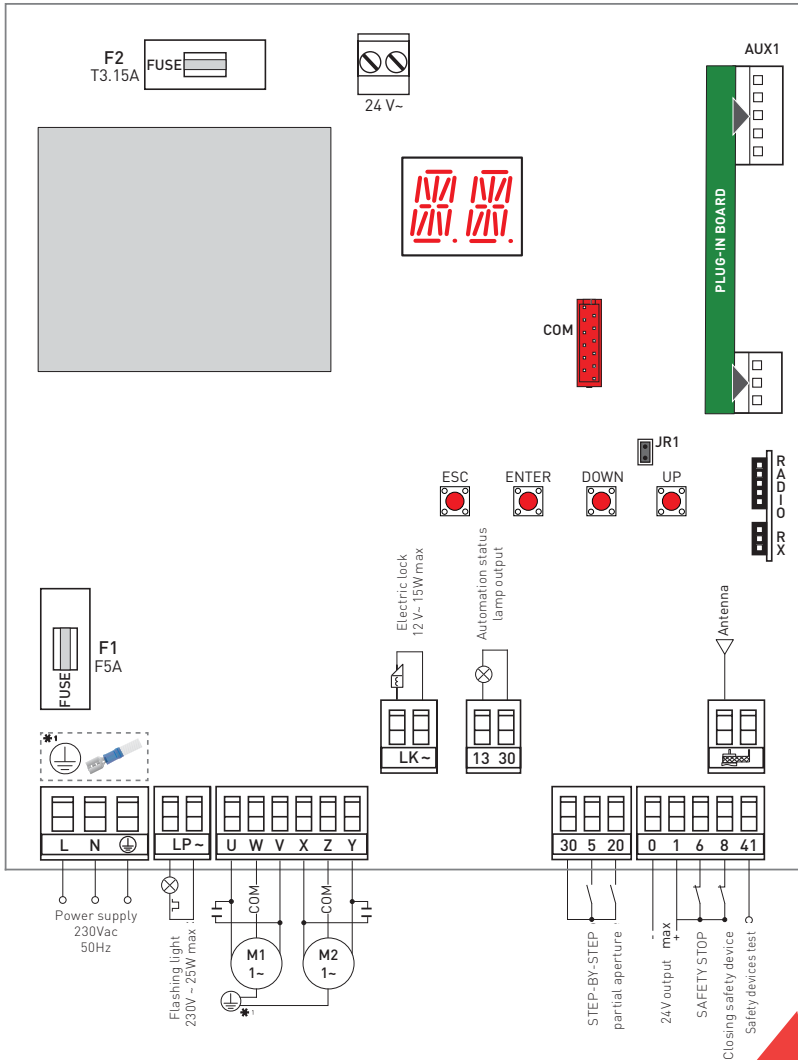

# Contents

	Subject	Page
<b>1.</b>	<b>General safety precautions</b>	<b>3</b>
1.1	Safety functions	4
<b>2.</b>	<b>EC Declaration of Conformity</b>	<b>4</b>
<b>3.</b>	<b>Technical specifications</b>	<b>4</b>
3.1	Applications	5
<b>4.</b>	<b>Installation and electrical connections</b>	<b>5</b>
4.1	Maintenance	7
4.2	Standard installation	7
4.3	Standard installation wiring diagram	8
<b>5.</b>	<b>Commands and safety devices</b>	<b>8</b>
5.1	Command inputs	9
5.2	Safety inputs	9
<b>6.</b>	<b>Outputs and accessories</b>	<b>9</b>
<b>7.</b>	<b>Jumper setting</b>	<b>10</b>
<b>8.</b>	<b>Application examples</b>	<b>11</b>
8.1	Automations with two swinging gates	11
8.2	Automations with one swinging gate	11
<b>9.</b>	<b>Using menus</b>	<b>12</b>
9.1	Switching the display on and off	12
9.2	Navigation keys	12
9.3	Menu map	13
<b>10.</b>	<b>Setting up product for first use</b>	<b>15</b>
10.1	WZ configuration wizard menu	15
10.2	Basic example of start-up	17
10.3	Frequently used menu sequences	18
10.3.1	Enabling configurations	18
10.3.2	Adding remote controls	18
10.3.3	Configuring the NC contact safety devices	18
<b>11.</b>	<b>Configuration and settings menu</b>	<b>18</b>
11.1	Main menu	18
11.2	Second level menu - AT (Automatic Configurations)	19
11.3	Second level menu - BC (Basic Configurations)	20
11.3.1	Additional BC level parameters that can be configured (available with AT → AA enabled)	21
11.4	Second level menu - BA (Basic Adjustment)	21
11.4.1	Additional BA level parameters that can be configured (available with AT → AA enabled)	23
11.5	Second level menu - RO (Radio Operations)	25
11.5.1	Additional RO level parameters that can be configured (available with AT → AA enabled)	26
11.6	Second level menu - SF (Special Functions)	27
11.6.1	Additional SF level parameters that can be configured (available with AT → AA enabled)	28
11.7	Second level menu - CC (Cycle Counter)	29
11.7.1	Additional CC level parameters that can be configured (available with AT → AA enabled)	29
11.8	Level two AP menu (Advanced parameters)	30
11.8.1	Additional configurable AP level parameters available with AT → AA enabled	31
<b>12.</b>	<b>Diagnostics</b>	<b>33</b>
12.1	Data Logging integrated in the board	33
12.1.1	Alarm counters	33
12.1.2	Alarm log	33
<b>13.</b>	<b>Signals visualised on the display</b>	<b>34</b>
13.1	Display of automation status	34
13.2	Display of safety devices and commands	35
13.3	Display of alarms and faults	36
<b>14.</b>	<b>Troubleshooting</b>	<b>38</b>

## Key



This symbol indicates instructions or notes regarding safety, to which special attention must be paid.



This symbol indicates useful information for the correct operation of the product.



Factory settings

# 1. General safety precautions



Failure to observe the information given in this manual may lead to personal injury or damage to the equipment.  
Keep these instructions for future reference

This installation manual is intended for qualified personnel only. Installation, electrical connections and adjustments must be performed in accordance with Good Working Methods and in compliance with the present standards. This product must only be used for the specific purpose for which it was designed. Any other use is to be considered improper and therefore dangerous. The manufacturer cannot be held responsible for any damage caused by improper, incorrect or unreasonable use. Read the instructions carefully before installing the product. Incorrect installation may cause danger.



The packaging materials (plastic, polystyrene, etc.) should not be discarded in the environment or left within reach of children, as they are a potential source of danger.

Before installing the product, make sure it is in perfect condition.

Do not install the product in explosive areas and atmospheres: the presence of inflammable gas or fumes represents a serious safety hazard.

The safety devices (photocells, safety edges, emergency stops, etc.) must be installed taking into account the applicable laws and directives, Good Working Methods, installation premises, system operating logic and the forces developed by the automation.

Before connecting the power supply, make sure the plate data correspond to those of the mains power supply. An omnipolar disconnection switch with a contact opening distance of at least 3mm must be fitted on the mains supply.

Check that there is an adequate residual current circuit breaker and a suitable overcurrent cutout upstream of the electrical installation in accordance with Good Working Methods and with the laws in force.

When requested, connect the automation to an effective earthing system that complies with current safety standards.



During installation, maintenance and repair operations, cut off the power supply before opening the cover to access the electrical parts.



The electronic parts must be handled using earthed antistatic conductive arms. The manufacturer of the motorisation device declines all responsibility if component parts not compatible with safe and correct operation are fitted.

Only use original spare parts when repairing or replacing products.

## 1.1 Safety functions

The Ditec LCA70 control panel has the following safety functions:

- obstacle recognition with force limiting.

The maximum response time of the safety functions is 0.5s. The reaction time to a faulty safety function is 0.5s.

The safety functions comply with the standards and performance level indicated below:

EN ISO 13849-1:2015 Category 2 PL=c

The safety function cannot be bypassed either temporarily or automatically. Fault exclusion has not been applied.

## 2. EC Declaration of Conformity

Entrematic Group AB declares that the Ditec LCA70 control panel is compliant with the fundamental requisites and other relevant requirements defined down by the following EC directives:

EMC Directive 2014/30/EU;

Low Voltage Directive 2014/35/EU.

RoHS Directive 2011/65/EU

Landskrona, 15-07-2020

Matteo Fino  
(President & CEO)



## 3. Technical specifications

Power supply	230V~ 50Hz
Power absorption	4A max
Fuses	F1= F5 A (Motor driver circuits) F2= T3.15 A (Electric lock circuit)
Motor output	230V AC 50Hz; 2 x 2A max; 1 x 4A max
Permanent power supply to accessories 0-30	24V $\overline{\text{=}}$ 0.3A max
Power supply to accessories 0-1	24V $\overline{\text{=}}$ 0.3 A max
24V~ accessory power supply	24V~ 0.3A max
Electric lock output	12V~ 15W (max 3s) 12V~ 0.1A (continuous)
230V~ flashing light output	25W max
Ambient temperature	-20°C - +55°C
Storable radio codes	100/200 see RO → MU → 10/20 (Paragraph 11.5)
Radio frequency	433.92 MHz (prod. code ZENRS included) or 868.35 MHz (prod. code ZENPRS optional)
Degree of protection of the container	IP55
Product size	187x261x103mm



**WARNING:** the total sum of the current values delivered from the 24V~ outputs 30 and 1 must never exceed 0.3A.



**NOTE:** The given operating and performance features can only be guaranteed with the use of DITEC accessories and safety devices.

### 3.1 Applications

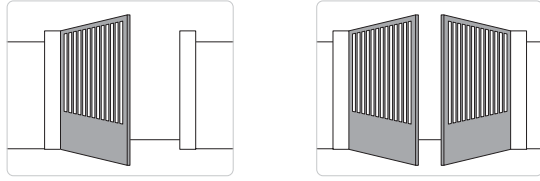

## 4. Installation and electrical connections

- Perforate the relevant points in the bottom part of the box (Fig. 4.1, page 6).
- Fix the control panel firmly in place. You are advised to use convex head screws (max head  $\varnothing$  10mm) with a cross imprint (the centre distance for the holes is shown in Fig. 4.2, page 6).
- Insert the cable glands and corrugated tubes from the lower side of the container.
- Before connecting the power supply, make sure the plate data correspond to those of the mains power supply.
- An omnipolar disconnection switch with a contact opening distance of at least 3mm must be fitted on the mains supply.
- Check there is an adequate residual current circuit breaker and overcurrent cutout upstream of the electrical system.
- In order to comply with the essential requisites of the Standards in force, reclose the cover once the wires have been connected to the terminals.



The connections to the mains power supply and to any possible low voltage wires (230V) in the section outside the control panel must be made on an independent channel separated from the connections to the command and safety devices (SELV = Safety Extra Low Voltage). The corrugated tubes must enter the control panel by a few centimetres via the holes on the base box.

- Make sure there are no sharp edges that may damage the cables.
- Make sure the mains power wires (230V) and the accessory wires (24V) are separated (Fig. 4.3).
- The cables must have dual insulation, be sheathed near the relative connection terminals, and be held in place with ties [B] (not supplied).
- After making the adjustments and settings, fix the cover in place with the screws supplied (Fig. 4.4, page 6).

Fig. 4.1

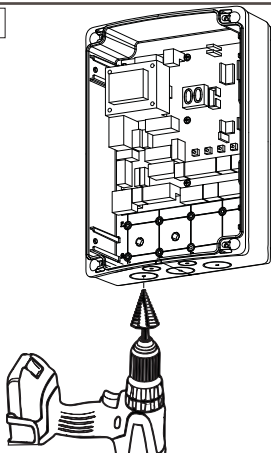

Fig. 4.2

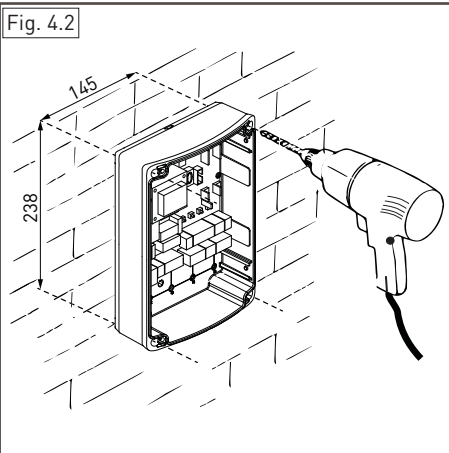

Fig. 4.3

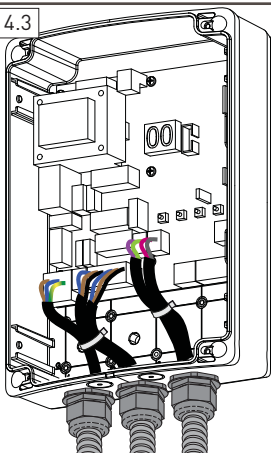
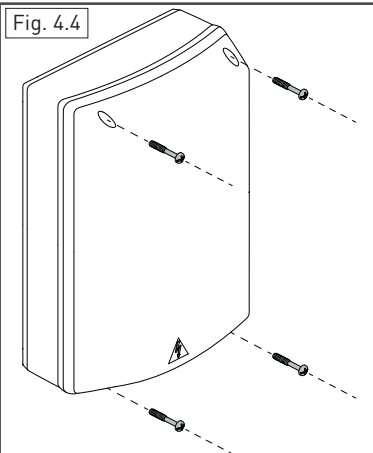

Fig. 4.4



## 4.1 Maintenance

The control panel doesn't require any special maintenance.

Make regular checks to ensure the seals on the box and the electrical connections are in good condition.

## 4.2 Standard installation

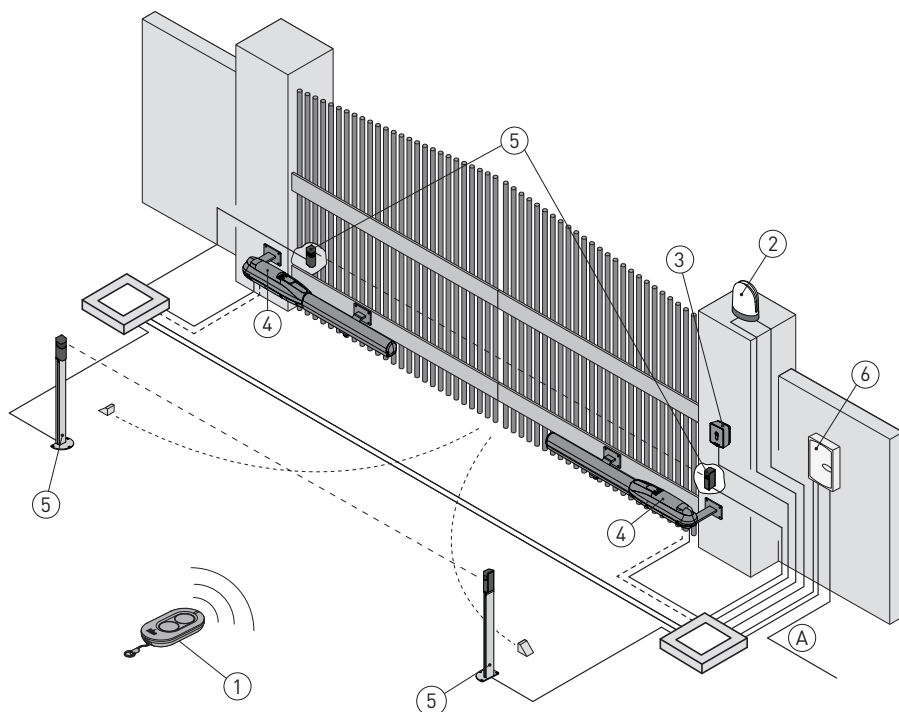

Ref.	Description	Cable
1	Transmitter	/
2	Flashing light	2 x 1mm <sup>2</sup>
	Antenna (integrated in the flashing light)	RG-58 coax cable (50Ω)
3	Key selector switch	4 x 0.5mm <sup>2</sup>
	Digital combination wireless keypad	/
4	Actuator (motor)	4 x 1.5mm <sup>2</sup>
	Extra low voltage limit switch unit (if present)	3 x 0.5mm <sup>2</sup>
5	Photocells	4 x 0.5mm <sup>2</sup>
6	Control panel	3G x 1.5mm <sup>2</sup>
A	Connect the power supply to a certified-compliant omnipolar switch (not included) with a contact opening distance of at least 3mm. Connection to the mains must be via an independent channel, separated from the connections to the command and safety devices.	

## 4.3 Standard installation wiring diagram

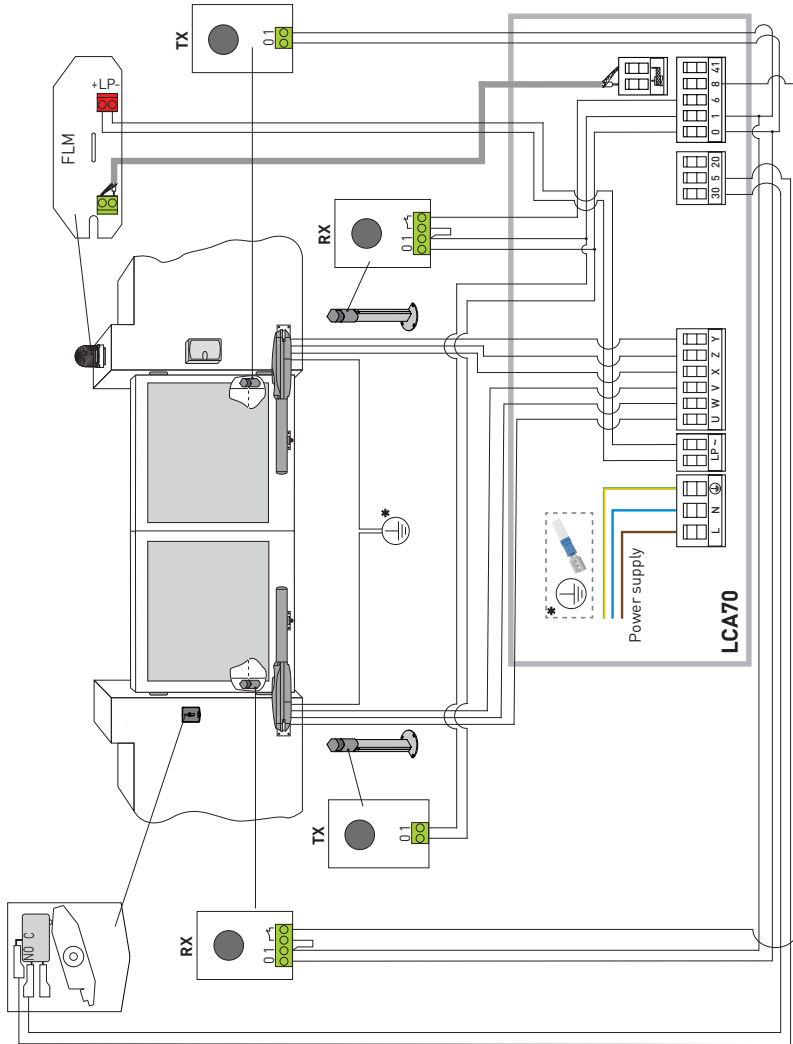

## 5. Commands and safety devices



You are advised to read paragraph 11 for all the details about the possible adjustments.



**WARNING:** terminal 30 (common positive for commands) has the same functions as terminal 1 and for this reason, the commands visible on the display are indicated with 1-5, 1-3, 1-4, etc.





**WARNING:** make a jumper for all NC contacts if not used, or deactivate them via the relative menu. Terminals with the same number are equal.



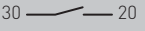

## 5.1 Command inputs

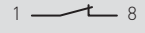
Command	Function	Description
	STEP-BY-STEP	When selecting <b>BC</b> → <b>CS</b> → <b>I-5</b> , closing the contact starts a sequential opening or closing operation: opening-stop-closing-opening. <b>WARNING:</b> if automatic closure is enabled, the duration of the stop can be defined by selecting <b>BC</b> → <b>SS</b> . The "opening-stop-closing-opening" sequence can be changed to "opening-stop-closing-stop-opening" by selecting <b>BC</b> → <b>PP</b> .
	OPENING	When selecting <b>BC</b> → <b>CS</b> → <b>I-3</b> , the closure of the contact activates an opening operation.
	PARTIAL APERTURE	The closure of the contact activates a partial opening operation. Once the automation stops, the partial opening control performs the opposite operation to the one performed before the stop.

## 5.2 Safety inputs





Command	Function	Description
	SAFETY STOP	For safety devices with self-test input: When selecting <b>AP</b> → <b>DB</b> → <b>S4I</b> , connect the output contact of the safety device to terminals 1-6 on the control panel (in series with the photocell output contact, if installed).
	Closing safety device	For safety devices with self-test input: When selecting <b>AP</b> → <b>DB</b> → <b>S4I</b> , connect the output contact of the safety device to terminals 1-8 on the control panel (in series with the photocell output contact, if installed).
	CLOSING/OPENING SAFETY DEVICE	For safety devices with self-test input: When selecting <b>AP</b> → <b>6B</b> → <b>S4I</b> , connect the output contact of the safety device to terminals 1-6-8 on the control panel (in series with the photocell output contact, if installed). If <b>6B</b> → <b>S4I</b> , <b>DB</b> and <b>DB</b> cannot be <b>P4I</b> or <b>S4I</b> .

## 6. Outputs and accessories

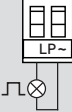

Output	Value of accessories	Description
	24V~ 0.3A max	<b>AC power supply to accessories</b> Output for power supply to external accessories.
	24V= 0.3A max	<b>Accessories power supply</b> Output for DC power supply to external accessories.
	24V= 3W max	<b>Automation status lamp (configurable)</b> For the operating mode of output 30-13, refer to the selection <b>BA</b> → <b>I3</b> . The current absorbed by the output 13, as well as the absorption of the accessory inserted in the AUX1 is to be counted in total deliverable from outputs 1 and 30 (300mA).
AUX 1	GOPAVRS LAB9 BIXR2 BIXPR2 BIXLR42 LAN7S	The control panel has two slots for plug-in command and safety boards. The action of the control board can be selected using <b>BC</b> → <b>AM</b> for AUX1. When using slot-in radio boards, remove the RDX module. The display will show <b>RV</b> . <b>WARNING:</b> the plug-in cards must be inserted and removed with the power supply disconnected. <b>NOTE:</b> the current absorption of the accessories installed in the slots AUX1 if associated with output "1" by the relative jumper, must be considered in the total current deliverable by output 1 (0.3A). Differently if associated to "30" must be considered in the calculation of the total current deliverable by output 30 (0.3A).



The total sum of the current values delivered from the 24V~ outputs 1 and 30 must never exceed 0.3A.

Output	Value of accessories	Description
	ANTENNA	Input for GOL148REA external antenna or rigid wire antenna supplied according to the operating frequency of the receiver module used.
	230V- 25W max	230V <b>flashing light</b> For connection of a 230V- flashing light with auto-flashing function.
	12V- / 15W (max 3s)  12V- / 0.1A (continuous)	<b>Electric lock</b> It is activated when the operation begins with the automation closed. To modify the operating mode of the LK output, refer to the selection <b>BA</b> → <b>LK</b> . <b>⚠ WARNING:</b> a short circuit in the electric lock causes fuse F2 to blow.
	ZENRS (included) ZENPRS (optional)	For installation of a ZENRS (433.92 MHz) or ZENPRS (868.35 MHz) type radio receiver module, purchasable separately. Operation is enabled by selecting <b>BC</b> → <b>RM</b> . When using slot-in radio boards, remove the RDX module. The display will show <b>RV</b> . <b>⚠ WARNING:</b> the modules must be inserted and removed with the power supply disconnected.
	BIXMR2	<b>COM</b> - Enables saving of operating configurations with function <b>SF</b> → <b>SV</b> . Saved configurations can be recalled with function <b>SF</b> → <b>RC</b> . The storage module allows the remote controls to be stored. If the control panel is replaced, the storage module being used can be inserted in the new control panel. <b>⚠ WARNING:</b> the storage module must be inserted and removed with the power supply disconnected, and paying attention to the positioning direction.

## 7. Jumper setting

Jumper	Description	OFF 	ON 
JR1	Display mode selection	<b>Display mode</b> The values and parameters present can be only displayed	<b>Maintenance mode</b> The values and parameters present can be displayed and modified. Activated maintenance mode is indicated by the permanent lit on of the right-hand point on the display.

# 8. Application examples



**WARNING:** make sure that the operating forces of the gate wings comply with the EN12453 standard.

## 8.1 Automations with two swinging gates

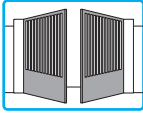

When the Ditec LCA70 control panel is used in applications for automations with two overlapping swinging gate wings, the following connections may be made:

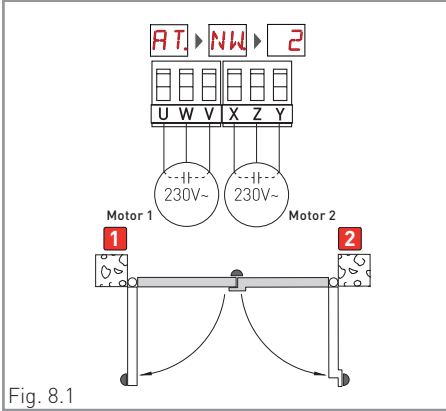

Fig. 8.1

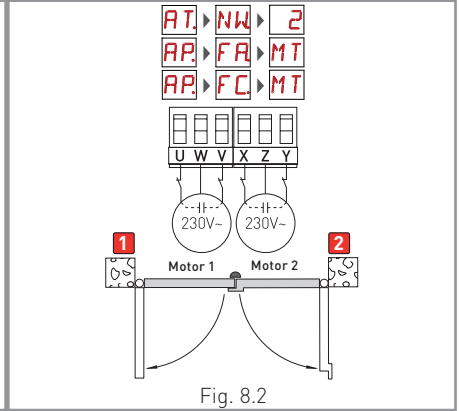
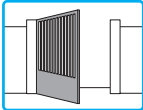

Fig. 8.2

[Fig. 8.1] Installation with mechanical end stops for opening and closure, and without the use of electric limit switches.

[Fig. 8.2] Installation with the use of electric limit switches for opening and closure, series connected to the motor's phases.

## 8.2 Automations with one swinging gate wing



When the Ditec LCA70 control panel is used in applications for automations with one swinging gate wing, the following connections may be made:

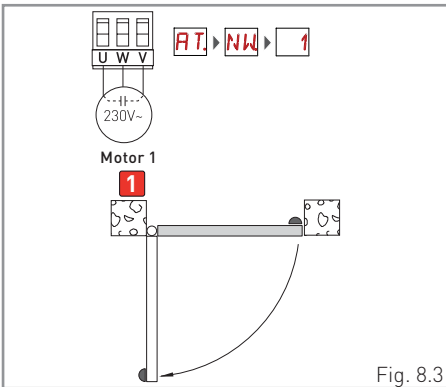

Fig. 8.3

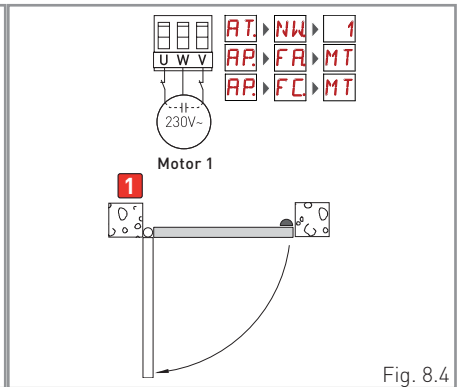

Fig. 8.4

[Fig. 8.3] Installation with mechanical end stops for opening and closure, and without the use of electric limit switches.

[Fig. 8.4] Installation with a mechanical end stop for closure and the use of electric limit switches for opening and closure, series connected to the motor's phases.

# 9. Using menus







**NOTE:** pressure on the keys may be quick (less than 2 s) or prolonged (longer than 2 s). Unless specified otherwise, quick pressure is intended. To confirm the setting of a parameter, prolonged pressing is necessary.

## 9.1 Switching the display ON and OFF

The procedure to switch on the display is as follows:



- press the key  ;
- the display functioning check starts   ;
- the first level menu is displayed  ;

The procedure to switch off the display is as follows:

- press the key 

**NOTE:** the display switches off automatically after 60 s of inactivity.

## 9.2 Navigation keys

- UP and DOWN keys:** for scrolling through level one or two menus and through the list of possible values for a specific parameter.
- ENTER key:** accesses the next menu level or the list of possible values for a menu parameter. Press and hold to confirm selection of the currently displayed parameter value.
- ESC key:** go back to previous step in navigation.
- Simultaneous pressing of the keys **UP** and **ENTER** performs an opening command.

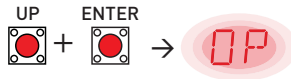

- Simultaneous pressing of the keys **DOWN** and **ENTER** performs a closing command.

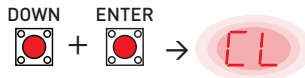

- Simultaneous pressing of the keys **UP** and **DOWN** performs a POWER RESET command. (interruption of the power supply and restart of the automation).



- Hold down the **UP** or **DOWN** key to begin fast menu scrolling.
- In some menus, the parameter measurement unit can be viewed by pressing the ENTER key once the value has been displayed.

Example: setting of 30 seconds for TC parameter.

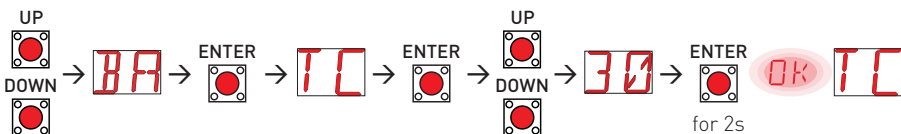

# 9.3 Menu map

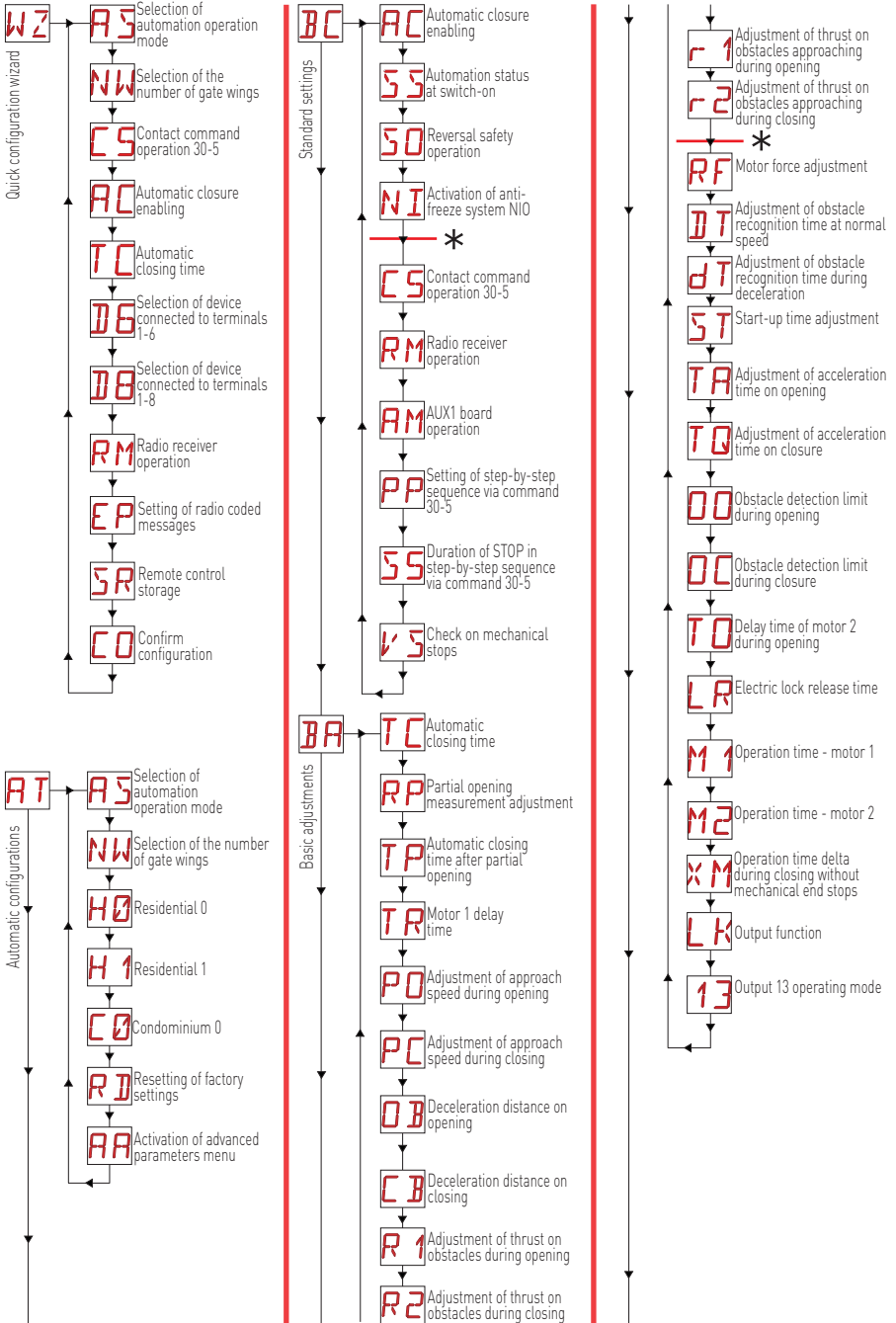

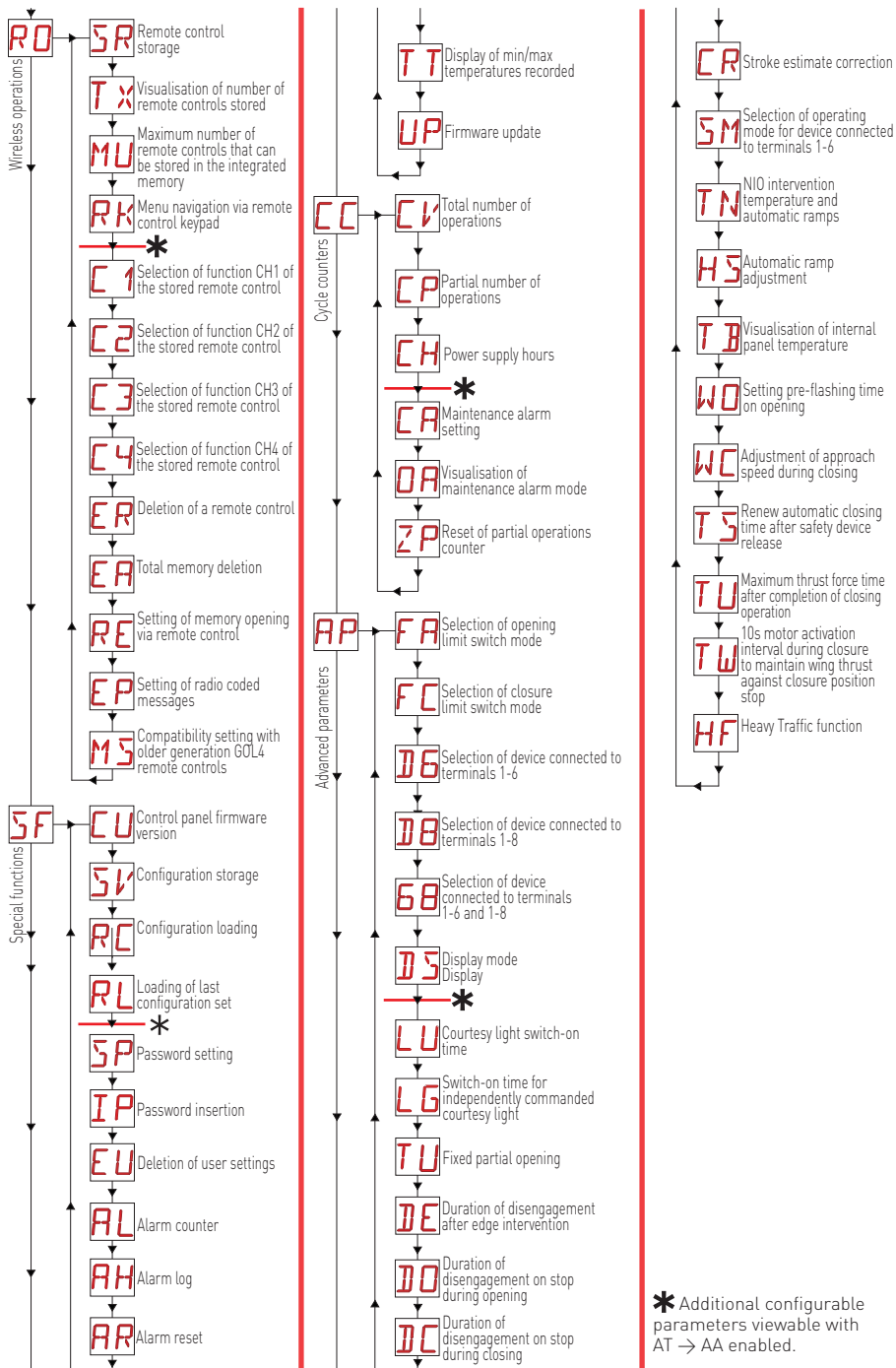

\* Additional configurable parameters viewable with AT → AA enabled.

# 10. Setting up product for first use

Use the WIZARD (WZ) wizard or the level two AT menu (automatic configuration) to set the product up rapidly with a quick configuration procedure [see parag. 11.2].

For detailed, customised configuration, use the main menus **BC**, **BA**, **RO**, **SF**, **CC**, **AP**.

## 10.1 WZ configuration wizard menu

**To access the WZ quick configuration wizard menu:**

Hold down the ENTER button for 2 seconds.

Once the message OK stops flashing, the first menu parameter:

**WZ** →  is displayed for 2 sec. **OK AS**

**To set a parameter:**

1. Press ENTER to access the configuration items.
2. Scroll UP/DOWN the possible options.
3. To confirm, press the ENTER button for 2 seconds. The selected value flashes and when it has finished, the next parameter appears.

**AS** →  →  **01** →  for 2 sec. **OK NW**

**List of parameters in WIZARD menu:**

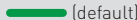
Display	Description
<b>WZ - Quick configuration wizard</b>  <b>AS</b>	<ul style="list-style-type: none"> <li>• <b>AS - Motor operating mode</b></li> </ul>
	<ul style="list-style-type: none"> <li>• <b>00. Automatic operation with deceleration</b>  (default)  <u>Recommended use:</u> for electromechanical motors installed on gates with unimpeded movement throughout entire stroke, and which use mechanical stops to determine the opening and closing strokes for every operation.  <u>Features:</u> <ul style="list-style-type: none"> <li>• Mechanical stop check function.</li> <li>• Deceleration control.</li> <li>• Obstacle detection with reversal.</li> <li>• Force set at maximum value possible.</li> </ul> </li> </ul>
	<ul style="list-style-type: none"> <li>• <b>01. Automatic operation without deceleration</b>  <u>Recommended use:</u> for electromechanical motors installed on gates with impeded movement in proximity of outermost opening and closing positions, and which use mechanical stops to determine the opening and closing strokes for every operation.  <u>Features:</u> <ul style="list-style-type: none"> <li>• Mechanical stop check function.</li> <li>• Constant speed throughout entire stroke.</li> <li>• Obstacle detection with reversal.</li> <li>• Force set at maximum value possible.</li> </ul> </li> </ul>
	<ul style="list-style-type: none"> <li>• <b>02. Timed operation with deceleration</b>  <u>Recommended use:</u> for electromechanical or hydraulic motors installed on gates with unimpeded movement throughout entire stroke, and which do not provide for mechanical stops on opening except as an emergency measure in case of overrun..  <u>Features:</u> <ul style="list-style-type: none"> <li>• Timed stroke based on M1 and M2 values.</li> <li>• Deceleration control.</li> <li>• Obstacle detection with reversal.</li> <li>• Force set at maximum value possible.</li> </ul> </li> </ul>

AS	<ul style="list-style-type: none"> <li>• <b>03. Timed operation without deceleration</b>  <u>Recommended use:</u> for electromechanical or hydraulic motors installed on gates with impeded movement in proximity of outermost opening and closing positions, and which do not provide for mechanical stops on opening except as an emergency measure in case of overrun.  <u>Features:</u> <ul style="list-style-type: none"> <li>• Timed stroke based on M1 and M2 values.</li> <li>• Constant speed throughout entire stroke.</li> <li>• Obstacle detection with reversal.</li> <li>• Force set at maximum value possible.</li> </ul> </li> <li>• <b>04. Timed operation with force limiting</b>  <u>Recommended use:</u> for electromechanical or hydraulic motors installed on particularly problematic gates with impeded movement throughout entire stroke, and which do not provide for mechanical stops on opening except as an emergency measure in case of overrun.  <u>Features:</u> <ul style="list-style-type: none"> <li>• Timed stroke based on M1 and M2 values.</li> <li>• Constant speed throughout entire stroke.</li> <li>• Obstacle detection disabled.</li> <li>• Reduced force value.</li> </ul> </li> </ul> <p> <b>WARNING:</b> this operating mode may only be set if the gate is fitted with self-monitoring safety sensing edges as the obstacle recognition function is disabled.</p>
NW	<b>NW - Number of wings.</b> <ul style="list-style-type: none"> <li>• 1: single wing</li> <li>• 2: two wings</li> </ul>
CS	<b>C5 - Operation of command associated with contact 30-5</b> <ul style="list-style-type: none"> <li>• <u>1-5</u>: step-by-step (default)</li> <li>• <u>1-3</u>: opening</li> </ul>
AC	<b>AC - Enabling of automatic closure</b> <ul style="list-style-type: none"> <li>• <u>ON</u>: enabled (default)</li> <li>• <u>OF</u>: disabled</li> </ul>
TC	<b>TC - Setting of automatic closing time [seconds]</b> [NOTE: only viewable visible if AC = ON was selected in previous step] <ul style="list-style-type: none"> <li>• from 0" to 59" with intervals of 1 second.</li> <li>• - from <u>1</u>" (default) to 2" with intervals of 10 seconds.</li> </ul>
D6	<b>D6 - Selection of device connected to terminals 1-6</b> <ul style="list-style-type: none"> <li>• <u>NO</u>: none</li> <li>• <u>PH</u>: photocells (default)</li> </ul> For other options, see the specific menu.
D8	<b>D8 - Selection of device connected to terminals 1-8</b> <ul style="list-style-type: none"> <li>• <u>NO</u>: none</li> <li>• <u>PH</u>: photocells (default)</li> </ul> For other options, see the specific menu.
RM	<b>RM - Radio receiver operation</b> <ul style="list-style-type: none"> <li>• <u>1-3</u>: step-by-step</li> <li>• <u>1-5</u>: opening (default)</li> </ul>
EP	<b>EP - AES (Encrypted Packet) reception setting</b> If the possibility to receive coded messages is enabled, the control panel will be compatible with remote controls of the "ENCRYPTED" type. <ul style="list-style-type: none"> <li>• <u>ON</u>: enabled</li> <li>• <u>OE</u>: disabled (default)</li> </ul>
SR	<b>SR - Remote control storage</b> When you press ENTER, SR starts to flash and you can associate the desired buttons. Once OK is displayed, SR starts to flash again and you can associate the next button. To quit, press ESC or ENTER for 2 seconds and go on to the next item. <b>NB:</b> if NO flashes on the display, the remote control may already be stored.
CO	<b>CO - Save Wizard settings</b> Here you can save the parameters that have previously been set. <ul style="list-style-type: none"> <li>• <u>YS</u>: to save and perform a card RESET</li> <li>• <u>NO</u>: to quit without saving and go back to a blank screen (central part only)</li> </ul> <b>NOTE:</b> the message CO and YS/NO sub-menus flash constantly.



### To save the configuration:

In the C0 parameter select YS (yes) and press the ENTER button for 2 seconds.

After saving, a board POWER RESET cycle is performed automatically:

C0 →  → YS →  for 2 sec. YS

### To quit without saving changes:

Select the option NO for the parameter C0 and then press and hold ENTER for 2 seconds

C0 →  → NO →  for 2 sec. NO

Or: from any main parameter, press the ESC button for 2 seconds. Example:

EP →  for 2 sec. NO

### NOTES:

- The set values are only stored on the card if they are saved using the C0 parameter.
- The parameter C0 and the YS/NO options flash constantly.
- After confirming a configuration parameter, the wizard moves on automatically to the next parameter.
- The UP/DOWN buttons may be used at any time, however, to scroll through parameters.
- There is no time limit for selecting and the wizard will not quit automatically.

## 10.2 Basic example of start-up

**i** **NOTE:** although this procedure applies to the “Automatic mode with deceleration” (AT → AS = 00), it also serves as a guide for the other modes.

**!** **WARNING:** the system must have sufficiently robust mechanical end stops or stop limit switches must be installed.

**!** **WARNING:** if the control panel is used to replace an identical control panel which is faulty, the last automation configuration can be reset by inserting the old control panel storage module into the new control panel and loading the last set configuration using the menu sequence SF → RL.

**!** **WARNING:** before using the automation, make sure that the operating forces of the gate wings comply with the EN 12453:2017 standard and subsequent revisions.

1. Turn on the power
2. Activate the WZ configuration wizard menu. Set the selections required for the system to be developed.
3. Make a jumper for the safety contacts 1-6 and 1-8. If not deactivated via the menu parameters AP → I6 and AP → I8.
4. With the automation idle in the intermediate position, give an opening command [ENTER + UP keys]. Check that the gate wings move in the correct direction. If the direction is not correct, invert the motor phase connections (U-V or X-Y) and repeat the procedure described above. Check that the automation reaches the gate open position and stops against the corresponding mechanical end stops (learning operation).
5. Give a closing command [ENTER + DOWN keys] or wait for the automatic closure to intervene if activated and check that the automation performs the corresponding operation by stopping on the mechanical closing end stops (learning operation).
6. Connect the safety devices after removing the jumpers 1-6, 1-8, or reactivating the corresponding inputs using the menu parameters AP → I6 and AP → I8. Make sure the various safety devices are operating correctly.

**i** **NOTE:** the first closing operation after a power cut or during the learning procedure is carried out with one gate wing at a time.

## 10.3 Frequently used menu sequences

### 10.3.1 Enabling the configurations

Step-by-step mode without automatic closure (residential use)

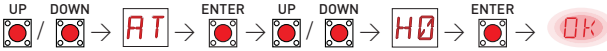

Step-by-step mode with automatic closure 1 min (residential use) [standard settings]

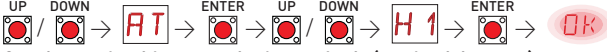

Opening mode with automatic closure 1 min (condominium use)



### 10.3.2 Adding remote controls

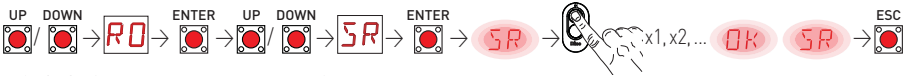

### 10.3.3 Configuring the NC contact safety devices

Example 1 - Configuring the photocells connected to terminals 1-8 and 1-6 [standard settings]

Set

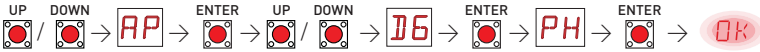

Example 2 - Configuring the safety edge with safety test simultaneously connected to terminals 1-6 and 1-8

Set

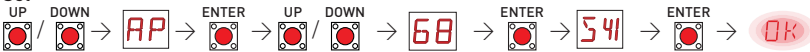



## 11. Configuration and settings menu





**NOTE:** depending on the type of automation and control panel, some menus may not be available.

### 11.1 Main menu

Display	Description
WZ	<b>WZ - Quick configuration wizard</b> Quick configuration menu
AT	<b>AT - Automatic Configuration</b> The menu allows you to manage the automatic configurations of the control panel.
BC	<b>BC - Basic Configuration</b> The menu allows you to display and modify the main settings of the control panel.
BA	<b>BA - Basic Adjustments</b> The menu allows you to display and modify the main adjustments of the control panel.
	<b>i NOTE:</b> some settings require at least three operations before they are set correctly.
RO	<b>RO - Radio Operations</b> The menu is used to manage the radio functions of the control panel.
SF	<b>SF - Special Functions</b> The menu allows you to set the password and manage the special functions in the control panel (alarm management, diagnostics enabling, FW updating).
CC	<b>CC - Cycle Counter</b> The menu allows you to display the number of operations carried out by the automation and manage the maintenance interventions.

Display	Description
	<b>AP - Advanced Parameters</b> The menu allows you to display and modify the advanced settings and adjustments of the control panel (limit switch mode, selection of devices connected to the terminals, disengagement duration adjustments, flashing light adjustments, etc.).  <b>NOTE:</b> some settings require at least three operations before they are set correctly.

From the main menu you can access the second level menu as follows:





- use the  and  keys to select the required function;
- press  to confirm.

After confirming the selection, you access the second level menu.





For each function of the main menu, there are also additional configurations that can be viewed by enabling the **AA** function (see the following paragraph). The factory settings for the various second level menu parameters are underlined in green.

 **NOTE:** to check if the parameters have actually been modified, quit the relative parameter and then access it again. The modifications will take effect from the next operation.

## 11.2 Level two menu - AT (Automatic Configuration)

AT - Automatic configuration	Display	Description	Selections available									
		<b>AS - Motor operating mode</b> - 0. <u>Automatic with deceleration</u> • Checking of mechanical end stops • Control of deceleration • Obstacle detection with reversal • Maximum force value - 1. <u>Automatic without deceleration</u> • Checking of mechanical end stops • Constant speed throughout entire stroke • Obstacle detection with reversal • Maximum force value - 2. <u>Timed operation with deceleration</u> • Timed stroke based on M1 and M2 values • Control of deceleration • Obstacle detection with reversal • Maximum force value - 3. <u>Timed operation without deceleration</u> • Timed stroke based on M1 and M2 values • Constant speed throughout entire stroke • Obstacle detection with reversal • Maximum force value - 4. <u>Timed operation with force limiting</u> • Timed stroke based on M1 and M2 values • Constant speed throughout entire stroke • Obstacle detection not activated • Reduced force value <div style="background-color: yellow; padding: 5px; margin-top: 10px;">  <b>WARNING:</b> this procedure may only be carried out if the gate is fitted with self-monitoring safety sensing edges as the obstacle recognition function is disabled.         </div>	  									
	<b>Value</b>	<b>Standard</b>	<b>P0</b>	<b>PC</b>	<b>OB</b>	<b>CB</b>	<b>VS</b>	<b>R1</b>	<b>R2</b>	<b>r1</b>	<b>r2</b>	<b>RF</b>
	0	<u>Automatic with deceleration</u>	13	13	10	10	ON	10	10	15	15	99
	1	<u>Automatic without deceleration</u>	25	25	5	5	ON	10	10	10	10	99
	2	<u>Timed with deceleration</u>	13	13	10	10	OFF	10	10	15	15	99
	3	<u>Timed without deceleration</u>	25	25	5	5	OFF	10	10	10	10	99
	4	<u>Timed with force limiting</u>	25	25	5	5	OFF	99	99	99	99	50

## AT - Automatic configuration

<b>NW</b>	<b>NW - Selection of the number of gate wings</b> In the case of automations with a single gate wing, connect motor 1.	0 1 0 2 <span style="border-bottom: 1px solid green; display: inline-block; width: 20px; margin-left: 100px;"></span>
<b>H0</b>	<b>H0 - Predefined setting, residential use 0, detached house</b> This selection loads predefined values for certain standard parameters: AC - Enable automatic closure : disabled C5 - step-by-step/opening command operation : Step-by-step RM - remote control operation : Step-by-step AM - AUX1 plug-in board operation : Step-by-step SS - Selection of automation status at start-up : open	
<b>H1</b>	<b>H1 - Predefined setting, residential use 1, detached house</b> This selection loads predefined values for certain standard parameters: AC - enabling of automatic closing : enabled TC - setting of automatic closing time : 1 minute C5 - step-by-step/opening command operation : Step-by-step RM - remote control operation : Step-by-step AM - AUX1 plug-in board operation : Step-by-step SS - Selection of automation status at start-up : closed	
<b>C0</b>	<b>C0 - Setting for condominium use</b> Opening and automatic closure at a preset value, with status at start-up closed.	
<b>RD</b>	<b>RD - Resetting of factory settings (SETTINGS RESET)</b> ENTER  → <b>RD</b> → ENTER  → <b>OK</b> ⌀2" ⌀2"	
<b>AA</b>	<b>AA - Temporary activation of additional configurable parameters for each main menu function</b> ENTER  → <b>OK</b>  ⌀2"	AAAA 

After activation you can scroll through the third level menus. The third level menus are activated for 30 min.

## 11.3 Level two BC menu (Basic settings)

Display	Description	Selections available
<b>AC</b>	<b>AC - Enabling of automatic closure</b> OF - Disabled ON - Enabled 1-2 - Dependent on input 30-2	OF <b>ON</b> 1-2 <span style="border-bottom: 1px solid green; display: inline-block; width: 20px; margin-left: 100px;"></span>
<b>SS</b>	<b>SS - Selection of automation status at start-up</b> OP - Open CL - Closed Indicates how the control panel considers the automation at the time of switch-on, or after a POWER RESET command.	OP <b>CL</b> <span style="border-bottom: 1px solid green; display: inline-block; width: 20px; margin-left: 100px;"></span>
<b>SO</b>	<b>SO - Enabling of reversal safety contact functioning during opening</b> ON - Enabled OF - Disabled When enabled (ON) with the automation idle, if the contact 1-8 is open, all operations are prevented. When disabled (OF) with the automation idle, if the contact 1-8 is open, opening operations are permitted.	<b>ON</b> <span style="border-bottom: 1px solid green; display: inline-block; width: 20px; margin-left: 100px;"></span> OF
<b>NI</b>	<b>NI - Enabling of NIO electronic anti-freeze system</b> ON - Enabled OF - Disabled When enabled (ON), it maintains the efficiency of the motor even at low ambient temperatures. <span style="background-color: #e0f0ff; padding: 2px;"> <b>NOTE:</b> for correct operation, the control panel must be exposed to the same ambient temperature as the motors.                     </span> The intervention temperature for the NIO system can be set by selecting <b>AP</b> → <b>TN</b> . <span style="background-color: #ffffe0; padding: 2px;"> <b>WARNING:</b> When the NIO system is in operation, the 230VAC (LP) flashing light output will remain activated. The NIO function cannot be used when motors with limit switches series connected to the phases (FA/FC= MT) are used.                     </span>	<b>ON</b> <span style="border-bottom: 1px solid green; display: inline-block; width: 20px; margin-left: 100px;"></span> OF <span style="border-bottom: 1px solid green; display: inline-block; width: 20px; margin-left: 100px;"></span>

IP2368EN

### 11.3.1 Additional configurable BC level parameters available with **AT** → **AA** enabled

BC - Basic settings	Display	Description	Selections available	
	<b>CS</b>	<b>C5 - Step-by-step/opening operation via 1-5 command (wakeup from stand-by)</b> 1-3 - Opening 1-5 - Step-by-step LG - Courtesy light command NO - Input 5 disabled	1-3	1-5
	<b>RM</b>	<b>RM - Radio receiver operation</b> 1-3 - Opening 1-5 - Step-by-step	1-3	1-5
	<b>AM</b>	<b>AM - Step-by-step/opening operation via command from AUX1 board</b> 1-3 - Opening 1-5 - Step-by-step NO - Disabled	1-3	1-5
	<b>PP</b>	<b>PP - Setting of step-by-step sequence via command 30-5</b> ON - Opening-Stop-Closing-Stop-Opening OF - Opening-Stop-Closing-Opening	ON	OF
	<b>SS</b>	<b>S5 - Duration of STOP in step-by-step sequence via command 30-5</b> ON - Permanent (automatic closure is excluded until a new command is given) OF - Temporary (the automatic closure timer intervenes, if enabled)	ON	OF
<b>VS</b>	<b>VS - Checking of mechanical end stops</b> When enabled (ON), with every power supply connection, the automation automatically checks the mechanical opening and closing end stops/stop limit switches. During the learning operation, the display shows the message <b>MO</b> and the closing operation involves one gate wing at a time ( <b>1C</b> ).	ON	OF	

### 11.4 Level two BA menu (Basic adjustments)

**NOTE:** make adjustments gradually and only after performing at least three complete operations to allow the control panel to be set correctly and detect any friction during operations.

BA	Display	Description	Selections available	
	<b>TC</b>	<b>TC - Setting of automatic closing time [s]</b> It is set with different intervals of sensitivity. from 0" to 59" with intervals of 1 second; from 1' to 2' with intervals of 10 seconds.	00	59
	<b>RP</b>	<b>RP - Adjustment of partial opening measurement [%]</b> Adjusts the percentage of operation in relation to the total opening of the automation. Partial opening is performed on gate wing 1. 10 - Minimum 99 - Maximum	10	99
<b>TP</b>	<b>TP - Setting of automatic closing time after partial opening [s]</b> It is set with different intervals of sensitivity. from 0" to 59" with intervals of 1 second; from 1' to 2' with intervals of 10 seconds.	00	59	

BA - Basic adjustments

Display	Description	Selections available
TR	<b>TR - Motor delay time [s]</b> Delay time for closure of gate wing 1 in relation to gate wing 2. 00 - 30s	00 0 30 10
PO	<b>PO - Adjustment of approach speed during opening</b> Indicates the speed from the end of the deceleration ramp to the end of the opening stroke 10 - Minimum 25 - Maximum	10 25 13
PC	<b>PC - Adjustment of approach speed during closing</b> Indicates the speed from the end of the deceleration ramp to the end of the closing stroke. 10 - Minimum 25 - Maximum	10 25 13
OB	<b>OB - Setting of deceleration/braking time during opening [s]</b> Indicates the time between the start of the deceleration ramp and the end of the opening stroke 1 - Minimum 30 - Maximum	0 1 30 10
CB	<b>OB - Setting of deceleration/braking time during closing [s]</b> Indicates the time between the start of the deceleration ramp and the end of the closing stroke 1 - Minimum 30 - Maximum	0 1 30 10
R1	<b>R1 - Adjustment of thrust on obstacles during normal operation at constant speed for both motors when opening. [%]</b> The control panel is fitted with a safety device which, when it detects an obstacle: - stops the opening movement and, if outside the limit area for detecting obstacles, performs a disengagement operation whose duration can be set with <b>AP</b> → <b>JE</b> ; - reverses the movement during closure operations outside the limit area for detecting obstacles; - stops the movement during closure operations within the limit area for detecting obstacles. The limit area for detecting obstacles during opening and closing is determined by the type of limit switch installed. If there is no limit switch, it is determined according to the selections <b>BA</b> → <b>00</b> and <b>BA</b> → <b>0C</b> : 00 - Minimum thrust 99 - Maximum thrust <b>i</b> NB: if set to 99%, obstacle detection is disabled during opening.	00 99 10
R2	<b>R2 - Adjustment of thrust on obstacles during normal movement at constant speed for both motors when closing. [%]</b> The control panel is fitted with a safety device which, when it detects an obstacle: - stops the opening movement and, if outside the limit area for detecting obstacles, performs a disengagement operation whose duration can be set with <b>AP</b> → <b>JE</b> ; - reverses the movement during closure operations outside the limit area for detecting obstacles; - stops the movement during closure operations within the limit area for detecting obstacles. The limit area for detecting obstacles during opening and closing is determined by the type of limit switch installed. If there is no limit switch, it is determined according to the selections <b>BA</b> → <b>00</b> and <b>BA</b> → <b>0C</b> : 00 - Minimum thrust 99 - Maximum thrust <b>i</b> NB: if set to 99%, obstacle detection is disabled during closing.	00 99 10

BA - Basic adjustments

Display	Description	Selections available
r1	<p><b>r1 - Adjustment of thrust on obstacles during end position approach phase at constant speed for both motors when opening. [%]</b></p> <p>The control panel is fitted with a safety device which, when it detects an obstacle:</p> <ul style="list-style-type: none"> <li>- stops the opening movement and, if outside the limit area for detecting obstacles, performs a disengagement operation whose duration can be set with <b>AP</b> → <b>JE</b>;</li> <li>- reverses the movement during closure operations outside the limit area for detecting obstacles;</li> <li>- stops the movement during closure operations within the limit area for detecting obstacles.</li> </ul> <p>The limit area for detecting obstacles during opening and closing is determined by the type of limit switch installed. If there is no limit switch, it is determined according to the selections <b>BA</b> → <b>00</b> and <b>BA</b> → <b>0C</b>:                      00 - Minimum thrust                      99 - Maximum thrust</p> <p><b>i NB:</b> if set to 99%, obstacle detection is disabled during opening.</p>	<p>0099 15</p>
r2	<p><b>r2 - Adjustment of thrust on obstacles during end position approach phase at constant speed for both motors when closing. [%]</b></p> <p>The control panel is fitted with a safety device which, when it detects an obstacle:</p> <ul style="list-style-type: none"> <li>- stops the opening movement and, if beyond the limit for obstacle detection, performs a disengagement operation, the duration of which is settable with <b>AP</b> → <b>JE</b>;</li> <li>- reverses the movement during closure operations beyond limit for obstacle detection;</li> <li>- stops the movement during closure operations within limit for obstacle detection.</li> </ul> <p>The limit area for detecting obstacles during opening and closing is determined by the type of limit switch installed. If there is no limit switch, it is determined on the basis of selections <b>BA</b> → <b>00</b> and <b>BA</b> → <b>0C</b>.                      00 - Minimum thrust                      99 - Maximum thrust</p> <p><b>i NB:</b> if set to 99%, obstacle detection is disabled during closing.</p>	<p>0099 15</p>

11.4.1 Additional BA level parameters that can be configured (available with **AT** → **AA** enabled)

**NOTE:** make adjustments gradually and only after performing at least three complete operations to allow the control panel to be set correctly and detect any friction during operations.

Display	Description	Selections available
RF	<p><b>RF - Motor force adjustment. [%]</b></p> <p>Enabled only during operations in which sensitivity R1, R2, r1 or r2 is set to 99%</p>	<p>2099 99</p>
DT	<p><b>DT - Adjustment of obstacle recognition time at normal speed. [s/100]</b></p> <p>20 - Minimum                      99 - Maximum</p>	<p>2099 40</p>
dT	<p><b>dT - Adjustment of obstacle recognition time during deceleration. [s/100]</b></p> <p>20 - Minimum                      99 - Maximum</p>	<p>2099 60</p>
ST	<p><b>ST - Adjustment of start time [s]</b></p> <p>During start-up, obstacle detection is disabled.                      2.0 - Minimum                      3.0 - Maximum</p>	<p>2.03.0 2.0</p>

BA - Basic adjustments

Display	Description	Selections available
TA	<b>TA - Adjustment of acceleration time during opening [s]</b> 0.5 - Minimum 1.5 - Maximum	0.5 ▶ 1.5 1.0
TQ	<b>TQ - Adjustment of acceleration time during closing [s]</b> 0.5 - Minimum 1.5 - Maximum	0.5 ▶ 1.5 1.0
OO	<b>OO - Obstacle detection limit during opening [%]</b> Indicates the percentage of the distance travelled during BA → OB in which disengagement is deactivated.	05 ▶ 99 99
OC	<b>OC - Obstacle detection limit during closing [%]</b> Indicates the percentage of the distance travelled during BA → CB in which reversal is deactivated.	05 ▶ 99 99
TO	<b>TO - Setting motor 2 opening delay time [s]</b> Adjustment, in seconds, of the delay time for starting the operation of motor 2, in relation to motor 1.	00 ▶ 30 03
LR	<b>LR - Electric lock release time [s]</b> If enabled, this indicates the electric lock activation time at the start of every opening operation with the automation closed.	0.5 ▶ 2.5 1.5
M1	<b>M1 - Operation time - motor 1 [s]</b> Adjustment, in seconds, of the total operation time for motor 1. 02 - Minimum 99 - Maximum <b>⚠ WARNING:</b> it is set with a sensitivity interval of 0.5s, shown when the decimal point on the right lights up. Example: 07 = 7 seconds / 0.7 = 7.5 seconds <b>i NOTE:</b> the setting of M1 is only active with BC → VS → OF.	02 ▶ 99 20
M2	<b>M2 - Operation time - motor 2 [s]</b> Adjustment, in seconds, of the total operation time for motor 2. 02 - Minimum 99 - Maximum <b>⚠ WARNING:</b> it is set with a sensitivity interval of 0.5s, shown when the decimal point on the right lights up. Example: 07 = 7 seconds / 0.7 = 7.5 seconds <b>i NOTE:</b> the setting of M2 is only active with BC → VS → OF.	02 ▶ 99 20
XM	<b>XM - Variation in time during closing without mechanical end stops. [s]</b> Variation in time to be added to M1 and M2 during closing. 00 - Minimum 30 - Maximum	00 ▶ 30 4
XT	<b>XT - Variation in operation time when reversing. [s]</b> Variation in time to be added to OB and CB. 00 - Minimum 30 - Maximum	00 ▶ 30 0



BA - Basic adjustments

Display	Description	Selections available
LK	<b>LK - LK output operating mode-</b> 00 - Courtesy light 01 - Activation of electric lock 02 - Activation of electric lock with release stroke 03 - Output activated with gate closed (for fail-safe electromagnets) 04 - Output activated with gate open 05 - Output activated with gate moving (can be used for electromagnets which need to be powered throughout opening or closing operations) 06 - Output activated during opening 07 - Output activated during closing 08 - Maintenance alarm 0N - Output always active	
13	<b>13 - 13 output operating mode</b> 00 - Courtesy light 01 - ON-OFF flashing light 02 - Permanent flashing light (auto-flashing) 03 - Proportional indicator light for open gate (quick flashing when opening, permanently on with gate open, slow flashing when closing) 04 - Indicator light for open gate (it comes on when opening starts and remains on until closure has been completed) 05 - Gate stationary and closed indicator light 06 - Gate stationary and fully open indicator light 07 - Gate moving indicator light (on both during opening and closing) 08 - Gate opening indicator light 09 - Gate closing indicator light 10 - Maintenance alarm 0N - Output always active	

11.5 Level two R0 menu (Radio operations)

R0 - Radio operations

Display	Description	Selections available
SR	<b>SR - Remote control storage</b> You can directly access the Remote control storage menu even with the display turned off, but only with the Display visualisation mode option set to 00 or 03: - for transmitting a remote control not present in the memory; - for transmitting an unstored channel of a remote control already present in the memory.	
	<b>WARNING:</b> if the display shows <b>NO</b> flashing, the remote control may already be stored.	
TX	<b>TX - Visualisation of counter showing remote controls stored</b> ENTER → 00 → 16 → 16 remote controls [example]	
MU	<b>MU - Indication of maximum number of remote controls that can be stored in the integrated memory</b> You can store a maximum of 100 or 200 remote control codes. ENTER → 10 or 20 → ENTER → OK 10 - 100 remote controls that can be stored 20 - 200 remote controls that can be stored	Selections available 10 20
	<b>WARNING:</b> selecting <b>MU</b> → 20 (200 remote controls), the configurations <b>U 1</b> and <b>U 2</b> saved with the <b>SF</b> → <b>SV</b> command will be lost. This also applies for the last configuration reloaded with <b>RL</b> . In addition, new configurations cannot be saved on <b>U 1</b> and <b>U 2</b> .	

**RK - Menu navigation using remote control keyboard**

ON - Enabled  
 OF - Disabled

With the display turned off, quickly type in the sequence of keys **3 3 2 4 1** from the stored remote control you want to use.  
 Make sure all the CH keys are stored.



**WARNING:** during navigation with a remote control keyboard ALL the stored remote controls are inactive.

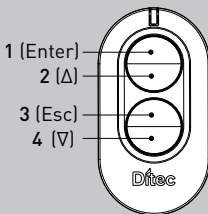

RK

ON

OF

To aid vision and adjustment (avoiding the need to continuously press the remote control), press the UP ↑ or DOWN ↓ key once to begin slowly scrolling through the parameters. This scrolling movement is faster if the UP ↑ or DOWN ↓ key is pressed twice.  
 To stop the scrolling, press ENTER.

To confirm your choice of parameter, press ENTER again.

To test any new setting, switch off the display and issue an opening command using key **3**.

Navigation using a remote control keyboard is automatically disabled after 4 minutes of inactivity or by setting **RK** → **OF**.

11.5.1 Additional configurable B0 level parameters available with **AT** → **AA** enabled



Display	Description	Selections available
C1	C1, C2, C3, C4 - Selection of CH1, CH2, CH3, CH4 function of stored remote control NO - No setting selected 1-3 - Opening command 1-4 - Closing command 1-5 - Step-by-step command P3 - Partial opening command LG - Command to switch the courtesy light on/off 1-9 - STOP command	NO 1-3 1-4 1-5 P3 LG 1-9
C2	If even just one (any) CH key of the remote control is stored, the opening or step-by-step command is implemented.	
C3	<b>i</b> NOTE: the <b>1-3</b> (opening) and <b>1-5</b> (step-by-step) options are available as alternatives, and depend on the selection <b>BC</b> → <b>RM</b> .	
C4	If 2-4 CH keys of a single remote control are stored, the functions matched in the factory with the CH keys are as follows: • CH1 = opening/step-by-step command; <b>1-3</b>   <b>1-5</b> (depending on parameter <b>RM</b> ); • CH2 = partial opening command; <b>P3</b> ; • CH3 = command to switch on/off the courtesy light; <b>LG</b> • CH4 = STOP command; <b>1-9</b> .	

**ER - Deletion of a single remote control**











ENTER → →

**EA - Total deletion of part of storage used for remote controls**

ENTER → → ENTER →

Display	Description	Selections available
RO	<b>RE - Setting memory opening from remote control</b> OF - Disabled ON - Enabled When enabled (ON), the remote programming is activated. To store new remote controls without using the control panel, refer to the remote control instructions.  <b>NOTE:</b> make sure you do not accidentally memorise unwanted remote controls.	ON OF
	<b>EP - Setting coded messages</b> If the possibility to receive coded messages is enabled, the control panel will be compatible with remote controls of the "ENCRYPTED" type.	OF ON
	<b>MS - Backward compatibility setting with older generation GOL4 remote controls.</b>  <b>NOTE:</b> firmware version 2.2.8 or higher is required. OF - Compatibility with old generation GOL4 and new ZEN remote controls. ON - Compatibility with ZEN series remote controls  <b>NOTE:</b> MS=ON is recommended if only ZEN series remote controls are used on the system.	OF ON

## 11.6 Second level menu - SF (Special Functions)

Display	Description	Selections available
SF - Special functions	<b>CU - Displaying the control panel firmware version</b> ENTER  → R. → 1.1 → Release 1.1 [example]	
	<b>SV - Saving user configuration on control panel storage module</b> ENTER  → U 1 → UP / DOWN  /  → U 2 → ENTER  → OK [example] ∅2"	U 1 U 2
	By selecting RO → MU → 10 you can save up to 2 personalised configurations in memory positions U 1 and U 2 only with the storage module present on the control panel.  <b>WARNING:</b> if RO → MU → 20 is selected, no user configuration can be saved on U 1 and U 2.	
	<b>RC - Configuration loading</b> ENTER  → 0 1 → UP / DOWN  /  → U 2 → ENTER  → OK [example] ∅2"	U 1 U 2
<b>RL - Loading of last configuration set</b> ENTER  → RL → OK ∅2"	the control panel automatically saves the last configuration set, and keeps it memorised in the storage module. In the event of a fault or the replacement of the control panel, the last configuration of the automation can be restored by inserting the storage module and loading the last configuration set.	

## 11.6.1 Additional configurable SF level parameters available with AT → AA enabled

Display	Description
SP	<p><b>SP - Setting the password</b></p> <p>ENTER → 01 → UP / DOWN → 07 → ENTER → OK [example] 2"</p> <p><b>i NOTE:</b> this can only be selected when the password is not set.</p> <p>Setting the password prevents unauthorised personnel from accessing selections and adjustments. You can delete the set password by selecting the sequence JR1=ON, JR1=OFF, JR1=ON.</p>
IP	<p><b>IP - Inserting the password</b></p> <p>ENTER → 01 → UP / DOWN → 07 → ENTER → OK [example] 2"</p> <p><b>i NOTE:</b> this can only be selected when the password is set.</p> <p>When the password is not inserted, you can access the display mode regardless of the selection made with JR1. When the password is inserted, you can access in maintenance mode.</p>
EU	<p><b>EU - Deletion of user configurations and last configuration set (can be called up from RL)</b></p> <p>ENTER → EU → ENTER → OK 2"</p>
AL	<p><b>AL - Alarm counter</b></p> <p>Used to view, in sequence, the counters of alarms that have been triggered at least once (alarm code + number of times triggered). With UP and DOWN, you can scroll through all the counters and see all the alarms recorded.</p>
AH	<p><b>AH - Alarm log</b></p> <p>Used to view, in sequence, alarms that have been triggered (up to a maximum of 20). With UP and DOWN, you can scroll through the entire alarm log. The display shows the alarm number and code, alternated. The highest number corresponds to the most recent alarm and the lowest number (0) corresponds to the oldest alarm.</p>
AR	<p><b>AR - Alarm reset</b></p> <p>Resets all the alarms in the memory (counters and log).</p> <p>ENTER → OK 2"</p> <p><b>i NOTE:</b> when the installation has been completed, you are advised to delete the alarms in order to facilitate future checks.</p>
TT	<p><b>TT - Display of min/max temperatures recorded</b></p> <ul style="list-style-type: none"> <li>- press for 2 sec to reset the values;</li> <li>- minimum value with active right decimal point.</li> </ul>
UP	<p><b>UP - Firmware update</b></p> <p>Activates the card bootloader in order to update the firmware.</p> <p>ENTER → OK 2"</p>

SF - Special functions

## 11.7 Second level menu - CC (Cycles Counter)

Display	Description
<b>CV</b>	<b>CV - Display of total operations counter</b> ENTER → 00 → 01 → 82 → 182 operations [example]
<b>CP</b>	<b>CP - Display of partial operations counter</b> ENTER → 00 → 07 → 16 → 716 operations [example]
<b>CH</b>	<b>CH - Display of power supply hour counter</b> ENTER → 00 → 02 → 15 → 215 operating hours [example]

### 11.7.1 Additional configurable CC level parameters available with **AT** → **AA** enabled

Display	Description	Selections available
<b>CA</b>	<b>CA - Setting the maintenance alarm</b> (factory setting - alarm deactivated: 0.0 00. 00) You can set the required number of operations (regarding the partial operations counter) for signalling the maintenance alarm. When the set number of operations is reached, the alarm message appears on the display ✓ 0. Example: Setting the maintenance alarm after 700 operations (00) (07) (00) ENTER → 00 → UP / DOWN → 00 → ENTER → 00 → UP / DOWN → 07 → ENTER → 00 → ENTER → 02	
<b>OA</b>	<b>OA - Selecting maintenance alarm display mode</b> 00 - Visualisation on display (alarm message ✓ 0) 01 - Visualisation on flashing light (with the automation idle, 4 flashes are made and then repeated every hour) and on display (alarm message ✓ 0). 02 - Visualisation on "open gate" indicator light (with the automation closed, 4 flashes are made and then repeated every hour) and on display (alarm message ✓ 0).	00 01 02
<b>ZP</b>	<b>ZP - Reset of partial operations counter</b> ENTER →  02 For correct functioning, you are advised to reset the partial operations counter: - after maintenance work; - after setting the maintenance alarm interval.	

## 11.8 Level two AP menu (Advanced parameters)

Display	Description	Selections available
FA	<b>FA - Motor 1 and 2 opening limit switch mode</b> NO: no limit switch (timed operation or with detection of stop) MT: stop limit switch series connected to the motor phase	NO MT <u>NO</u>
FC	<b>FC - Motor 1 and 2 closing limit switch mode</b> NO: no limit switch (timed operation or with detection of stop) MT: stop limit switch series connected to the motor phase	NO MT <u>NO</u>
D6	<b>D6 - Selection of device connected to terminals 1-6</b> NO - None SE - Safety sensing edge (if contact 1-6 opens, 10 cm disengagement is implemented after stop). S41 - Safety edge with safety test (if contact 1-6 opens, after the stop there is a disengagement of a duration depending on the selection <b>AP</b> → <b>DE</b> ) PH - Photocells P41 - Photocells with safety test	NO SE S41 PH P41 <u>PH</u>
D8	<b>D8 - Selection of device connected to terminals 1-8</b> NO - None SE - Safety edge S41 - Safety edge with safety test PH - Photocells P41 - Photocells with safety test	NO SE S41 PH P41 <u>PH</u>
68	<b>68 - Selection of the device simultaneously connected to terminals 1-6 and 1-8</b> NO - None SE - Safety edge S41 - Safety edge with safety test If different from NO, the simultaneous opening of inputs 1-6 and 1-8 causes: - movement stop and reversal during a closing operation. - movement stop and disengagement of a duration depending on the selection <b>AP</b> → <b>DE</b> during an opening operation.	NO SE S41
DS	<b>DS - Setting of display visualisation mode without alarm</b> 00 - No information displayed. 01 - Countdown to automatic closure displayed. 02 - Automation status (see paragraph 13.1). 03 - Commands and safety devices (see paragraph 13.2). <b>i</b> <b>NOTE:</b> the setting <b>01</b> allows you to see when a radio transmission is received, for range checks.	00 00 00 01 <u>00 01</u> 00 02 00 03

AP - Advanced parameters

## 11.8.1 Additional configurable AP level parameters available with **AT** → **AA** enabled



**NOTE:** make adjustments gradually and only after performing at least three complete operations to allow the control panel to be set correctly and detect any friction during operations.

Display	Description	Selections available
LU	<p><b>LU - Setting switch-on time for courtesy light [s]</b>                      To enable this parameter, set at least one of the selections <b>BA</b> → <b>EO</b> or <b>BA</b> → <b>FF</b> as a courtesy light.                      It is set with different intervals of sensitivity.</p> <p><b>NO</b> - Disabled                      - from 01" to 59" with intervals of 1 second                      - from 1' to 2' with intervals of 10 seconds                      - from 2' to 3' with intervals of 1 minute  <b>ON</b> - Permanently enabled (switched off via remote control)</p> <p><b>i</b> <b>NOTE:</b> the courtesy light switches on at the start of each operation.</p>	
LG	<p><b>LG - Switch-on time for independently commanded courtesy light [s]</b>                      To enable this parameter, set at least one of the selections <b>BA</b> → <b>EO</b> or <b>BA</b> → <b>FF</b> as a courtesy light.                      It is set with different intervals of sensitivity.</p> <p><b>NO</b> - Disabled                      - from 01" to 59" with intervals of 1 second                      - from 1' to 2' with intervals of 10 seconds                      - from 2' to 3' with intervals of 1 minute  <b>ON</b> - Switched on and off with remote control</p> <p><b>i</b> <b>NOTE:</b> the switching on of the light does not depend on the start of an operation, but can be commanded separately using the special remote control key.</p>	
PT	<p><b>PT - Fixed partial opening</b>  <b>ON</b> - Enabled  <b>OF</b> - Disabled</p> <p>If ON, a partial opening command given on the partial opening position is ignored.                      With contact 30-20 closed (for example with the timer or manual selector), the gate will partially open. If it is then fully opened (command 30-3) and reclosed (even with automatic closing), it will stop at the partial opening position.</p>	
DE	<p><b>DE - Disengagement duration if an edge is triggered [s]</b>                      Regulates the duration of the disengagement when an edge (active) is triggered during opening or closure.                      In the case of gates with two wings, it acts on both wings.  <b>00</b> - Disable.</p>	
DO	<p><b>DO - Duration of disengagement on stop during opening [s/100]</b>                      Regulates the duration of the disengagement on the mechanical opening stop.  <b>00</b> - Disabled.  <b>99</b> - Maximum.</p>	
DC	<p><b>DC - Duration of disengagement on stop during closing [s/100]</b>                      Regulates the duration of the disengagement on the mechanical opening stop.  <b>00</b> - Disabled.  <b>99</b> - Maximum.</p>	
CR	<p><b>CR - Stroke estimate correction [%]</b>  <b>DO NOT USE</b> (diagnostic purposes only)</p>	

AP - Advanced parameters

AP - Advanced parameters

SM	<p><b>SM - Selection of operating mode of device connected to terminals 1-6</b></p> <p>00 - During opening operation, open state of safety contact stops movement (with disengagement if <b>DB</b> → <b>SE / S4</b> ).</p> <p>01 - During opening operation, open state of safety contact stops movement (with disengagement if <b>DB</b> → <b>SE / S4</b>). The interrupted operation is resumed when the contact is closed again.</p> <p>02 - During opening operation, open state of safety contact stops movement (with disengagement if <b>DB</b> → <b>SE / S4</b>). An opening operation is performed when the contact is closed again.</p> <p>03 - During closing operation, open state of safety contact reverses movement. During the opening operation, the safety device is ignored.</p> <p>04 - During opening operation, open state of safety contact stops movement (with disengagement if <b>DB</b> → <b>SE / S4</b>). The interrupted opening operation is resumed when the contact is closed again. During the closing operation, the safety device is ignored.</p> <p>05 - During closing operation, open state of safety contact stops and then reverses movement. During the opening operation, the opening of the safety contact stops the movement (with disengagement if <b>DB</b> → <b>SE / S4</b>).</p>	00 0 1	
TN	<p><b>TN - Setting of intervention temperature for the NIO electronic anti-freeze system and automatic HS ramps [°C]</b></p> <p>This value does not refer to the ambient temperature, but to the internal control panel temperature.</p>	-920	20
HS	<p><b>HS - Automatic ramp adjustment</b></p> <p>ON - Enabled OF - Disabled</p> <p>When enabled (ON), at low ambient temperatures the start time <b>ST</b> increases up to the maximum value and the acceleration time <b>TA</b> and <b>TQ</b> diminishes to the minimum value.</p> <p><b>i</b> <b>NOTE:</b> for correct operation the electronic panel must be at the same ambient temperature as the engines.</p> <p>The activation temperature is settable by selecting <b>AP</b> → <b>TN</b>.</p>	ON OF	
TB	<p><b>TB - Permanent display of the internal control panel temperature [°C]</b></p>	ON OF	
WO	<p><b>WO - Setting of pre-flashing time on opening [s]</b></p> <p>Adjustment of the lead time for the switch-on of the flashing light, in relation to the start of the opening operation from a voluntary command.</p> <p>00 - Minimum 05 - Maximum.</p>	00 05	00
WC	<p><b>WC - Setting of pre-flashing time on closing [s]</b></p> <p>Adjustment of the lead time for the switch-on of the flashing light, in relation to the start of the closing operation from a voluntary command.</p> <p>00 - Minimum 05 - Maximum.</p>	00 05	00
TS	<p><b>TS - Setting of renewal of automatic closing time after safety device release [%]</b></p> <p>00 - Minimum 99 - Maximum.</p>	00 99	99
TU	<p><b>TU - Time at maximum thrust force after completion of closing operation (e.g. to relatch electric lock) - 0.0 to 9.9</b></p> <p><b>i</b> <b>NOTE:</b> Setting the parameter to 0.0 disables thrust.</p>	0.0 9.9	



<p>TW</p>	<p>TW - Thrust renewal time against closure position stop. 00 to 59 (minutes), 1h, 2h,... 9h. This parameter may be used to hold the gate closed with motors which require thrust to be re-applied periodically to effectively hold the gate in a closed position (e.g. in case of pressure loss in hydraulic actuators when not in use). At each time interval set, the hydraulic unit delivers closing pressure to the motors for 10 seconds and activates the flashing lamp (if installed) to warn of the manoeuvre.</p> <p><b>i</b> NOTE: Setting the parameter to 0.0 disables function.</p> <p><b>!</b> WARNING: Check that the thrust deliverable by the motors is within the limits specified by the standard EN 12453:2017. Only use this function if effectively necessary.</p>	<p>00.59 1h.9h</p>
<p>HF</p>	<p>HF - Heavy Traffic function ON - Enabled OF - Disabled</p> <p>When this function is enabled, the automatic reclosing time is increased automatically to 3 min in the event of a series of consecutive operations due to frequent aperture requests (e.g. at peak traffic times in a condominium application), to reduce wait times for users and to limit motor wear and the risk of overheating.</p>	<p>ON OF</p>

## 12. Diagnostics

### 12.1 Data Logging integrated in the board

The Ditec LCA70 control panel is equipped with an internal system which allows the installer to check whether any alarms have been triggered, see how many times each alarm has been triggered and view a log of the last twenty alarms.

#### 12.1.1 Alarm counter

With the third level menus enabled (AT → AA), go to SF → AL to see all the alarms recorded by the control panel. The display alternately shows the alarm code and the number of times it was triggered.

Example: 00 - 05 - 00 - 05 - ....

Use the  and  keys to scroll through the entire list of alarm counters.

#### 12.1.2 Alarm log

With the third level menus enabled (AT → AA), go to SF → AH to see the alarm log (the last 20 alarms recorded). The display shows the alarm number and code, alternated. The highest number corresponds to the most recent alarm and the lowest number corresponds to the oldest alarm.

Example: - 1 - 00 - - 1 - 00 - ....

Use  and  to scroll through the alarm log.

# 13. Signals visualised on the display

**i** **NOTE:** depending on the type of automation and control panel, certain visualisations may not be available.

## 13.1 Display of automation status

**i** **NOTE:** the automation status display mode is only visible with Display visualisation mode set to 02.

AP ▶ IS ▶ 02

Display	Description	Display	Description
	Automation closed		Automation opening
	Automation open		Automation closing, from partial opening
	Automation stopped in intermediate position		Automation in partial opening
	Automation closing		Automation partially open

## 13.2 Display of safety devices and commands



**NOTE:** the safety device and command display mode is only visible with Display visualisation mode set at 01 or 03.

AP ▶ DS ▶ 01

AP ▶ DS ▶ 03



Display	Description	Display	Description
1-2	1-2 - Automatic closure enable command.	S.2.	S.2. - Stop detection during aperture operation - motor 2.
1-3	1-3 - Opening command.	00.	00. - Obstacle detection limit reached during aperture operation - motor 1.
1-5	1-5 - Step-by-step command.	0.0.	00. - Obstacle detection limit reached during aperture operation - motor 2.
1-6	1-6 - Safety device with opening and closing stop.	0C.	00. - Obstacle detection limit reached during closure operation - motor 1.
1-8	1-8 - Safety device with reversal during closing operation.	0.C.	00. - Obstacle detection limit reached during closure operation - motor 2.
68	68 - Device connected simultaneously to terminals 1-6 and 1-8.	RV	RV - Enable/disable built-in radio receiver via RDX.
P3	P3 - Partial opening command.	MQ	MQ - Mechanical end stop learning operation in progress.
RX	RX - Radio reception (from any memorised key of a transmitter stored in memory)	HT	HT - Motor heating (NIO function) in progress.
NX	NX - Radio reception (from any non-memorised key) <b>NOTE:</b> with the selection AP → DS → 01, it is also visualised when a command is received from a non-stored transmitter.	J1	JR1 - Change in jumper JR1 status.
EX	EX - Rolling-code radio reception out of sequence	PC	PC - Connected HOST (Personal Computer) recognised.
EP	EP - Radio reception not compliant with parameter configuration RO → EP	ES	ES - Switch to Green Mode (energy-saving)
CX	CX - Command received from AUX1 board	1C	1C - Closing operation (1 gate wing at a time)
S1.	S1. - Stop detection during closure operation - motor 1.	LG	LG - Courtesy light/garden light command
S.1.	S.1. - Stop detection during closure operation - motor 2.	HO	HO - Pressure hold function activation for hydraulic pistons
S2.	S2. - Stop detection during aperture operation - motor 1.	HS	HS - Activation of increased thrust force function in closure operation

### 13.3 Visualisation of alarms and faults



**WARNING:** the visualisation of alarms and faults is possible with any visualisation selection. The signalling of alarm messages takes priority over all other displays.

Type of alarm	Display	Description	Operation
Mechanical alarm	<b>MB</b>	<b>MB</b> - Motor 1 not detected during operation.	Check the motor 1 connection and if the thermal switch has tripped.
	<b>MC</b>	<b>MC</b> - Motor 2 not detected during operation (if 2-motor operation is set).	Check the motor 2 connection and if the thermal switch has tripped.
	<b>MH</b>	<b>MH</b> - Gate wing overlap incorrect	Check that the motor which is the first to make the opening (M1) is connected as shown in fig. 1.
	<b>MI</b>	<b>MI</b> - Detection of fifth consecutive obstacle	Check for the presence of permanent obstacles along the stroke of the automation. Check the settings / operating of any limit switches.
	<b>OD</b>	<b>OD</b> - Obstacle on wing 1 detected during aperture.	Check for the presence of obstacles along the automation stroke.
	<b>OE</b>	<b>OE</b> - Obstacle on wing 1 detected during closure.	Check for the presence of obstacles along the automation stroke.
	<b>OF</b>	<b>OF</b> - Obstacle on wing 2 detected during aperture.	Check for the presence of obstacles along the automation stroke.
Settings alarm	<b>OG</b>	<b>OG</b> - Obstacle on wing 2 detected during closure.	Check for the presence of obstacles along the automation stroke.
	<b>S6</b>	<b>S6</b> - Incorrect setting of safety device test	Check the configuration of parameters <b>I6</b> , <b>I8</b> , <b>68</b> . If <b>68</b> → <b>54</b> , <b>I6</b> and <b>I8</b> cannot be <b>P4</b> or <b>54</b> .
Service alarm	<b>V0</b>	<b>V0</b> - Maintenance request.	Proceed with the scheduled maintenance intervention.

Type of alarm	Display	Description	Operation
Internal control panel alarm	I5	I5 - No voltage 0-30 (faulty voltage regulator or short-circuit on accessories)	Check there is no short circuit in connection 0-30. If the problem persists, replace the control panel.
	I6	I6 - Excessive voltage 0-30 (faulty voltage regulator)	Replace the control panel.
	I7	I7 - Internal parameter error - value outside limits	Reset. If the problem persists, replace the control panel.
	I8	I8 - Program sequence error	Reset. If the problem persists, replace the control panel.
	IA	IA - Internal parameter error (EEPROM/FLASH)	Reset. If the problem persists, replace the control panel.
	IB	IB - Internal parameter error (RAM)	Reset. If the problem persists, replace the control panel.
	IC	IC - Operation time out error (>3 min).	Manually check that the gate wing moves freely. If the problem persists, replace the control panel.
	IE	IE - Power supply circuit fault	Reset. If the problem persists, replace the control panel.
	IM	IM - TRIAC alarm - motor 1 short circuited or always ON.	Reset. Check the settings / operating of any limit switches. If the problem persists, replace the control panel.
	IN	IN - TRIAC alarm - motor 2 short circuited or always ON.	Reset. If the problem persists, replace the control panel.
	IU	IU - Motor 1 voltage reading circuit test error.	Reset. If the problem persists, replace the control panel.
	IV	IV - Motor 2 voltage reading circuit test error.	Reset. If the problem persists, replace the control panel.
	XX	XX - Firmware reset commanded by simultaneous usage	 +  keys
	WD	WD - Firmware reset not commanded	
Radio operations alarm	R0	R0 - Storage module installed containing over 100 stored remote controls. <b>WARNING:</b> the <b>RO→MU→20</b> setting is made automatically.	To save the system configurations on the storage module, delete any stored remote controls and bring the total to less than 100. Set <b>RO → MU → 10</b> .
	R3	R3 - Storage module not detected	Insert a storage module.
	R4	R4 - Storage module not compatible with the control panel	Insert a compatible storage module.
	R5	R5 - No serial communication with the storage module	Replace the storage module.
	R6	R6 - Specific storage module for testing installed.	
Power supply alarm	P1	P1 - Microcontroller voltage too low.	Check the control panel is powered correctly.

Type of alarm	Display	Description	Operation
Accessories alarm	A0	A0 - Test of safety sensor on contact 6 failed.	Check the safety device is working properly. If the supplementary safety board is not inserted, check the safety test is disabled.
	A1	A1 - Test of safety sensor connected simultaneously to contacts 6 and 8 failed.	Check the wiring and correct operation of the safety sensor.
	A3	A3 - Test of safety sensor on contact 8 failed.	Check the safety device is working properly. If the supplementary safety board is not inserted, check the safety test is disabled.
	AB	AB - Overload on output 30-13	Check the device connected to output 30-13 is working properly.

## 14. Troubleshooting

Problem	Possible cause	Alarm signalling	Operation	
The control panel does not switch on	No power supply.		Check the power supply cable and the F1 fuse.	
	Internal fault		Contact Technical Service	
The automation does not open or close	No power.		Check the power supply cable and the F1 fuse.	
	Short circuited accessories.	IS	Disconnect all accessories from terminals 0-1 or 0-30 (a voltage of 24V= must be present) and reconnect them one at a time. Contact Technical Support Service	
	Blown line fuse.		Replace fuse F1.	
	Safety contacts are open.	1-6 6R	1-8	Check that the safety contacts are closed correctly (NC).
	Safety contacts not correctly connected or self-controlled safety edge not functioning correctly.	A0 A1 A3	1-6 1-8 6R	Check connections to terminals 6-8 on control panel and connections to the self-controlled safety edge.
	Photocells activated.	1-6	1-8	Check that the photocells are clean and operating correctly.
	The safety edges connected to 6R and 8R are pressed or blocked	6R	8R	Check the resistance values of the safety edges.
	The automatic closure does not work.			Issue any command. If the problem persists, contact Technical Service
	Faulty motor or tripping of thermal switch.	M0 MC		Check motor connection, if the problem persists, contact Technical Service.
	External safety devices not activating	Incorrect connections between the photocells and the control panel.		Check that 1-6 / 1-8 is displayed Connect NC safety contacts together in series and remove any jumpers on the control panel terminal board.
			Check the AP → 06 and AP → 08 setting	

Problem	Possible cause	Alarm signalling	Operation
The automation opens/closes briefly and then stops.	There is a presence of friction.	MI OD OE OF OG	Manually check that the automation moves freely and check the R1/R2 adjustment. Check that the limit switches, if installed, are working correctly Contact Technical Service
The remote control has limited range and does not work with the automation moving.	The radio transmission is impeded by metal structures and reinforced concrete walls.		Install the antenna outside.
			Replace the transmitter batteries.
The remote control does not work	No storage module or incorrect storage module.	R0 R3 R5	Switch the automation off and plug in the correct storage module. Check the correct memorisation of the transmitters on the built-in radio. If there is a fault with the radio receiver that is built into the control panel, the remote control codes can be read by removing the storage module.

All the rights concerning this material are the exclusive property of Entrematic Group AB. Although the contents of this publication have been drawn up with the greatest care, Entrematic Group AB cannot be held responsible in any way for any damage caused by mistakes or omissions in this publication.

We reserve the right to make changes without prior notice.

Copying, scanning or changing in any way is expressly forbidden unless authorised in writing by Entrematic Group AB.

 The crossed-out wheelie bin symbol indicates that the product should be disposed of separately from normal household waste. The product should be recycled in accordance with local environmental regulations for waste disposal. By separating a product marked with this symbol from household waste, you will help reduce the volume of waste sent to incinerators or land-fill and minimise any potential negative impact on human health and the environment.

