

Ditec

REM

SAFETY SENSOR FOR AUTOMATIC SWING DOORS

User's Guide for product version 0400 and higher
See product label for serial number

DESCRIPTION

The REM is a safety sensor for automatic swing doors based on active infrared technology. It secures the moving door leaf. To do so, the modules must be installed on the top rail on both sides of the door leaf.

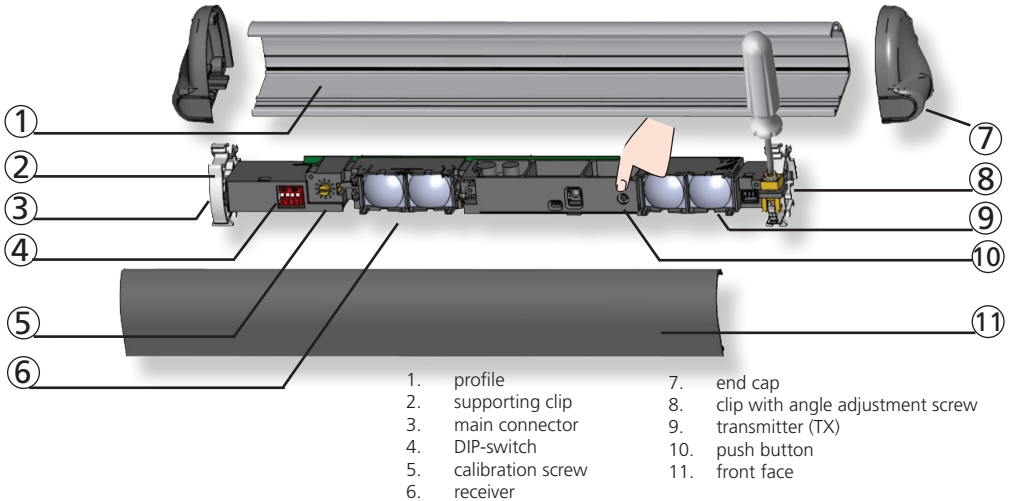

TECHNICAL SPECIFICATIONS

Technology:	active infrared with background suppression
Emission field:	400 mm (W) x 70 mm (D) (at 2 m mounting height; 4 spots active)
Mounting height:	1.3 m to 3.5 m
Reaction time:	64 ms (typ)
Max. presence time:	infinite
Supply voltage:	12 V - 24 V AC +/-10% ; 12 V - 30 V DC -5%/+10% (to be operated from SELV compatible power supplies only)
Max current consumption:	95 mA @ 24 V AC/ 70 mA @ 24 V DC; 170 mA @ 12 V AC/ 130 mA @ 12 V DC (MASTER) 85 mA @ 24 V AC/ 60 mA @ 24 V DC; 180 mA @ 12 V AC/ 113 mA @ 12 V DC (other modules)
Output:	2 relays (free of potential contact)
Max. contact voltage	42 V AC/DC
Max. contact current	1 A (resistive)
Max. switching power	30 W (DC) / 60 VA (AC)
Input:	1 optocoupler (free of potential contact)
Max. contact voltage:	30 V
Voltage threshold:	high: >10 V DC; low: <1 V DC
Max. number of modules:	4 (up to 6 if 24 V DC)
Reflectivity:	min. 5% at IR-wavelength of 850 nm
Degree of protection:	IP54
Temperature range:	-25 °C to +55 °C; 0-95% relative humidity, non condensing
Expected lifetime:	20 years
Conformity:	DIN 18650-1: ch. 5.7.4; EN 16005 ch. 4.6.8; EN 12978; IEC/EN 61508 (SIL2) EN ISO 13849-1 Performance Level «c» CAT. 2 (under the condition that the door control system monitors the sensor at least once per door cycle)

1 MOUNTING THE PROFILE



Mount the profiles as close as possible to the closing edge. Leave 2 cm for the black end caps. Take the position of the white clips into account before drilling and fastening the screws.

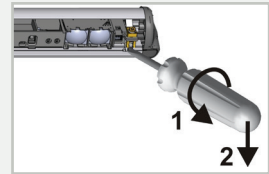

To loosen the modules, please use a screwdriver.

2 POSITIONING THE MODULES

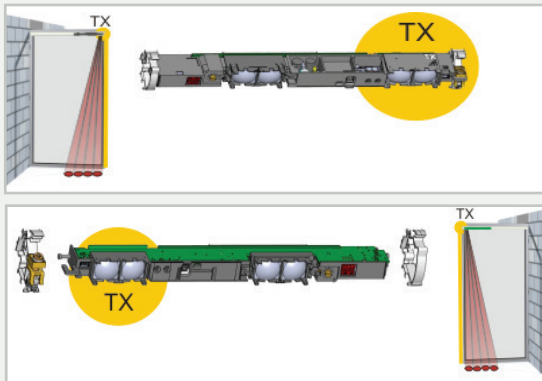

The transmitter (TX) should be placed next to the door edges that need to be protected.

The angle adjustment clip should be next to the transmitter.

Turn the module if necessary.

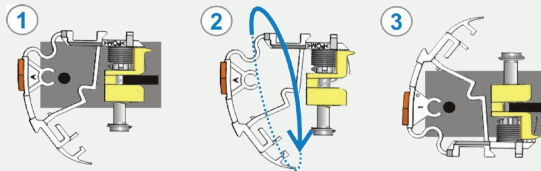

When a module needs to be turned:

1. detach the clips
2. turn them by 180°
3. reattach

3 WIRING

	WEL ¹	DAB ¹	SPRINT ¹	
12-24 V AC-DC	GREEN 0	1	0	POWER SUPPLY
	BROWN 1	5	1	
	YELLOW 1	1	1	
COM	WHITE 1	1	1	STOP IMPULSE OPENING SIDE
NC	BLACK 6	3	9	
NO *	PINK 1	1	1	
COM	GREY 1	1	1	REVERSE IMPULSE CLOSING SIDE
NO	VIOLET 8	2	8	
NC *	RED** 41	5	G1	
	BLUE** 0	4	0	TEST OUPUT***

The module connected to the door controller becomes the **MASTER**.

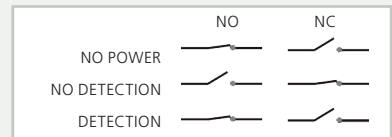

Plug the SLAVE CABLE between the modules in one of the two placements.

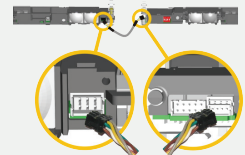

* Output status when sensor is operational

** For compliance with EN 16005 and DIN 18650, connection to door controller test output is required.

*** If door controller is not tested: connect BLUE to 0 V and RED to +12 V - 30 V DC.

¹ Please refer to specific operator manual

4 SETTINGS

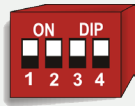

FACTORY VALUE

ON

MOUNTING
SIDE

RELAY 1
OPENING SIDE

OFF

RELAY 2
CLOSING SIDE

LED during detection:
R1 > RED
R2 > GREEN

FREQUENCY

FREQ A

Set different
frequencies on
modules close to
each other.

BACKGROUND

ON

Not enough background
reflectivity: switch to OFF

UNCOVERED
ZONE

HIGH*

LOW

Approximate values at 2 m:
high = 40 cm, low = 15 cm

* Recommended for most applications.
Mounting height > 2.7 m: set to LOW for
EN 16005 and DIN 18650-conformity.

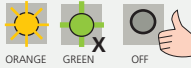
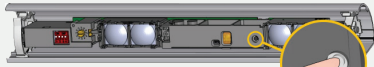

After changing a DIP-switch, the orange LED flashes.

A LONG push on the push button of the **MASTER**
confirms the settings of ALL MODULES.

Afterwards, a number of green flashes (x) indicates
the number of connected modules.

5 CALIBRATION

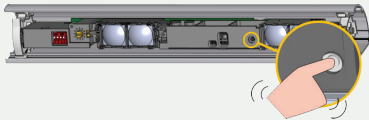

A SHORT push on the button of the **MASTER** launches a
calibration on ALL MODULES.

Do not stand in the detection field!



RED-GREEN



OFF

When the LED is off on all modules, the detection zone is OK.



GREEN

The detection zone is too short:
turn the screw clockwise.



RED

The detection zone is too long:
turn the screw anticlockwise.



ORANGE

Step out of the detection field.

If necessary, change angle or switch off background (DIP 3 = OFF).



5

Launch a new calibration.

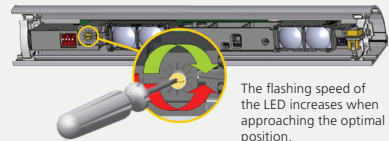

The flashing speed of
the LED increases when
approaching the optimal
position.

6 DOOR SAFETY CHECK

IMPORTANT: Test the good
functioning of the installation
before leaving the premises.

If necessary, position spots
closer to or away from the door
and **relaunch a calibration**.

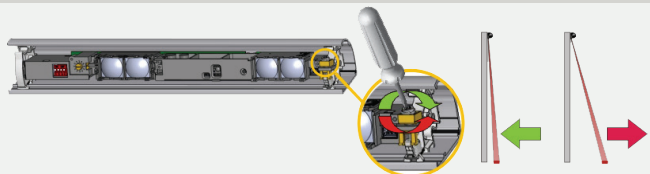

LED-SIGNALS

 	The RED or GREEN LED is ON sporadically or permanently.	Bad calibration	<ol style="list-style-type: none"> 1 Launch a calibration.
		Bad adjustment of the uncovered zone.	<ol style="list-style-type: none"> 1 Check if the DIP-switch 4 is in correct position. 2 Launch a calibration.
		The sensor is disturbed by lamps or another sensor.	<ol style="list-style-type: none"> 1 Select a different frequency for each module (DIP 2). 2 Launch a calibration.
	The sensor does not react, but a calibration can be launched.	The monitoring is activated, but the test input is not powered.	<ol style="list-style-type: none"> 1 Check wiring. <ul style="list-style-type: none"> - Door control with test: Connect RED and BLUE wires to test output. - Door control without test: Connect BLUE to 0 V and RED to +12 V - 30 V DC.
	The ORANGE LED is on permanently.	The sensor encounters a memory problem.	<ol style="list-style-type: none"> 1 Send the sensor back for a technical check-up.
	The ORANGE LED flashes quickly.	DIP-switch setting awaiting confirmation.	<ol style="list-style-type: none"> 1 Confirm the DIP-switch setting: long push on the push button.
	The ORANGE LED flashes 1 x every 3 seconds.	The sensor signals an internal fault.	<ol style="list-style-type: none"> 1 Cut and restore power supply. 2 If orange LED flashes again, replace sensor.
	The ORANGE LED flashes 2 x every 3 seconds.	Power supply is out of limit.	<ol style="list-style-type: none"> 1 Check power supply (tension, capacity). 2 Reduce the cable length or change cable.
	The ORANGE LED flashes 3 x every 3 seconds.	Communication error between modules.	<ol style="list-style-type: none"> 1 Check wiring between modules. 2 Launch a module count: long push on push button of MASTER.
	The ORANGE LED flashes 4 x every 3 seconds.	The sensor receives not enough IR-energy.	<ol style="list-style-type: none"> 1 Launch a new calibration. 2 Step out of the detection field. 3 Change angle of spots. 4 Switch off background (DIP 3: OFF).
	The ORANGE LED flashes 5 x every 3 seconds.	Calibration error	<ol style="list-style-type: none"> 1 Check mounting height. 2 Change position of calibration screw. 3 Launch a new calibration. 4 Switch off background (DIP3: OFF)

- The device cannot be used for purposes other than its intended use. All other uses cannot be guaranteed by the manufacturer of the sensor.
- The manufacturer of the door system is responsible for carrying out a risk assessment and installing the sensor and the door system in compliance with applicable national and international regulations and standards on door safety.
- The manufacturer of the sensor cannot be held responsible for incorrect installations or inappropriate adjustments of the sensor.
- Only trained and qualified personnel may install and setup the sensor.
- The warranty is invalid if unauthorized repairs are made or attempted by unauthorized personnel.

