



Last version of this manual

IP1812EN • 2023-03-08

Ditec



Ditec CUBIC

Technical Manual

Swing gates automation

(Original instructions)

Index

Subject		Page
1.	General safety precautions	21
	General safety precautions for the user	22
2.	Declaration of incorporation of partly completed machinery	23
2.1	Machinery Directive	23
3.	Technical specifications	24
3.1	Operating instructions	24
4.	Standard installation	25
5.	Examples applications	26
6.	Installation	27
6.1	Preliminary checks	27
6.2	Foundation case installation	27
6.3	Lever mechanisms installation	27
6.4	Wing release installation	27
6.5	Geared motor installation	27
6.6	Installation with CUBIC6L-CUBIC6LG	28
6.7	Installation with CUBIC6TC	28
6.8	Installation CUBIC6FM	29
7.	Electrical connections	29
8.	Routine maintenance plan	30
	Operating instructions	31
	Manual release instructions	33

Legend



This symbol indicates instructions or notes relating to safety which require special attention.



This symbol indicates useful information for the correct operation of the product.

1. General safety precautions



ATTENTION! Important safety instructions. Please follow these instructions carefully.

Failure to observe the information given in this manual may lead to severe personal injury or damage to the equipment. Keep these instructions for future reference.

This manual and those for any accessories can be downloaded from www.ditecautomations.com

This installation manual is intended for qualified personnel only • Installation, electrical connections and adjustments must be performed by qualified personnel, in accordance with Good Working Methods and in compliance with the current regulations • Read the instructions carefully before installing the product. Wrong installation could be dangerous • Before installing the product, make sure it is in perfect condition.



The packaging materials (plastic, polystyrene, etc.) should not be discarded in the environment or left within reach of children, as they are a potential source of danger • Do not install the product in explosive areas and atmospheres: the presence of inflammable gas or fumes represents a serious safety hazard • Make sure that the temperature range indicated in the technical specifications is compatible with the installation site • Before installing the motorization device, make sure that the existing structure, as well as all the support and guide elements, are up to standards in terms of strength and stability. Verify the stability and smooth mobility of the guided part, and make sure that no risks of fall or derailment subsist. Make all the necessary structural modifications to create safety clearance and to guard or isolate all the crushing, shearing, trapping and general hazardous areas • The motorization device manufacturer is not responsible for failure to observe Good Working Methods when building the frames to be motorized, or for any deformation during use • The safety devices (photocells, safety edges, emergency stops, etc.) must be installed taking into account the applicable laws and directives, Good Working Methods, installation premises, system operating logic and the forces developed by the motorized door or gate • The safety devices must protect against crushing, cutting, trapping and general danger areas of the motorized door or gate. Display the signs required by law to identify hazardous areas • Each installation must bear a visible indication of the data identifying the motorized door or gate • Before connecting the power supply, make sure the plate data correspond to those of the mains power supply. An omnipolar disconnection switch with a contact opening distance of at least 3 mm must be fitted on the mains supply. Check that there is an adequate residual current circuit breaker and a suitable overcurrent cutout upstream of the electrical installation in accordance with Good Working Methods and with the laws in force • When requested, connect the motorized door or gate to an effective earthing system that complies with the current safety standards • Before commissioning the installation to the end user, make sure that the automation is adequately adjusted in order to satisfy all the functional and safety requirements, and that all the command, safety, and manual release devices operate correctly.



During maintenance and repair operations, cut off the power supply before opening the cover to access the electrical parts • The protection cover of the operator must be removed by qualified personnel only.



The electronic parts must be handled using earthed antistatic conductive arms. The manufacturer of the motorization declines all responsibility if component parts not compatible with safe and correct operation are fitted • Only use original spare parts for repairing or replacing products • The installer must supply all information concerning the automatic, manual and emergency operation of the motorized door or gate, and must provide the user with the operation and safety instructions

General safety precautions for the user



These precautions are an integral and essential part of the product and must be supplied to the user.

Read them carefully since they contain important information on safe installation, use and maintenance.

These instructions must be kept and forwarded to all possible future users of the system.

This product must only be used for the specific purpose for which it was designed.

Any other use is to be considered improper and therefore dangerous. The manufacturer cannot be held responsible for any damage caused by improper, incorrect or unreasonable use.

Avoid operating in the proximity of the hinges or moving mechanical parts. Do not enter within the operating range of the motorised door or gate while it is moving.

Do not obstruct the motion of the motorised door or gate, as this may cause a dangerous situation.

The motorised door or gate may be used by children over the age of 8 and by people with reduced physical, sensorial or mental abilities, or lack of experience or knowledge, as long as they are properly supervised or have been instructed in the safe use of the device and the relative hazards.

Children must be supervised to make sure they do not play with the device, nor play/remain in the sphere of action of the motorised door or gate.

Keep remote controls and/or any other command devices out of the reach of children, to avoid any accidental activation of the motorised door or gate.

In the event of a product fault or malfunction, turn off the power supply switch. Do not attempt to repair or intervene directly, and contact only qualified personnel.

Failure to comply with the above may cause a dangerous situation.

Any repair or technical intervention must be carried out by qualified personnel.

Cleaning and maintenance work must not be carried out by children unless they are supervised.

To ensure that the system works efficiently and correctly, the manufacturer's indications must be complied with and only qualified personnel must perform routine maintenance on the motorised door or gate. In particular, regular checks are recommended in order to verify that the safety devices are operating correctly.

All installation, maintenance and repair work must be documented and made available to the user.

Only lock and release the door wings when the motor is switched off. Do not enter within the operating range of the wing.



To dispose of electrical and electronic equipment correctly, users must take the product to special "recycling centres" provided by the municipal authorities.

2. Declaration of incorporation of partly completed machinery

[Directive 2006/42/EC, Annex II-B)

The manufacturer ASSA ABLOY Entrance Systems AB, with headquarters in Lodjursgatan 10, SE-261 44 Landskrona, Sweden, declares that the Ditec CUBIC6-CUBIC6H-CUBIC6HV automation for swing gates:

- is designed to be installed on a manual gate to form a machine pursuant to Directive 2006/42/EC. The manufacturer of the motorised gate must declare conformity with Directive 2006/42/EC (annex II-A) prior to initial machine start-up;
- complies with the applicable essential safety requirements indicated in Annex I, Chapter 1 of the Directive 2006/42/EC;
- complies with the Electromagnetic Compatibility Directive 2014/30/EU;
- complies with the RED Directive 2014/53/EU;
- the technical documentation complies with Annex VII-B of the Directive 2006/42/EC;
- the technical documentation is managed by the Technical Office of Ditec Spa (with headquarters in Largo U. Boccioni 1 – 21040 Origgio (VA) – ITALY) and is available upon request, sending an e-mail to info@ditecautomations.com ;
- a copy of the technical documentation will be given to competent national authorities, following a suitably justified request.

Landskrona, 11-11-2020

Matteo Fina
(chairman)

2.1 Machinery Directive

Pursuant to the Machinery Directive (2006/42/EC), the installer who motorises a door or gate has the same obligations as the manufacturer of machinery and as such must:

- prepare the technical data sheet which must contain the documents indicated in Annex V of the Machinery Directive;
(the technical data sheet must be kept and placed at the disposal of competent national authorities for at least ten years from the date of manufacture of the motorised door or gate);
- draw up the EC Declaration of Conformity in accordance with Annex II-A of the Machinery Directive and deliver it to the customer;
- affix the EC marking on the motorised door or gate, in accordance with point 1.7.3 of Annex I of the Machinery Directive.

3. Technical data

	CUBIC6	CUBI6H	CUBIC6HV
Power supply	230 V~ 50 Hz	24 V=	24 V=
Absorption	1,5 A	12 A	12 A
Couple	340 Nm	340 Nm	220 Nm
Capacitor	10 µF	-	-
Opening time	18 s/90°	12+25 s/90°	6+13 s/90°
Max opening	110°-180° (see page 26)	110°-180° (see page 26)	110°-180° (see page 26)
Service class	3 - FREQUENT	4 - INTENSIVE	4 - INTENSIVE
Intermittence	S2 = 15 min S3 = 25%	S2 = 30 min S3 = 50%	S2 = 30 min S3 = 50%
Temperature	min -20°C max +55°C min -35°C max +55°C (with NIO enabled)	min -20°C max +55°C min -35°C max +55°C (with NIO enabled)	min -20°C max +55°C min -35°C max +55°C with NIO enabled
Degree of protection	IP67	IP67	IP67
Control panel	LCA70 - LCA80	LCU40H-HJ	LCU40H-HJ
Applications m = leaf width kg = leaf weight			

3.1 Operating instructions

Service class: 3 (minimum 30 cycles a day for 10 years or 60 cycles a day for 5 years).

Use: FREQUENT (For vehicle or pedestrian accesses to town houses or small condominiums with frequent use).

Service class: 4 (minimum 100 cycles a day for 10 years or 200 cycles a day for 5 years)

Use: INTENSIVE (For vehicle or pedestrian accesses to large condominiums, industrial or commercial complexes and parking lots with very frequent use).

- Performance characteristics are to be understood as referring to the recommended weight (approx. 2/3 of maximum permissible weight). When used with the maximum permissible weight a reduction in the above mentioned performance can be expected.
- Service class, running times, and the number of consecutive cycles are to be taken as merely indicative Having been statistically determined under average operating conditions, and are therefore not necessarily applicable to specific conditions of use.
- Each automatic entrance has variable elements such as: friction, balancing and environmental factors, all of which may substantially alter the performance characteristics of the automatic entrance or curtail its working life or parts thereof (including the automatic devices themselves). The installer should adopt suitable safety conditions for each particular installation.



Incorrect drainage of the foundation box may damage the gearmotor and make the warranty void. Follow the installation instructions and perform the necessary periodic maintenance.

4. Standard installation

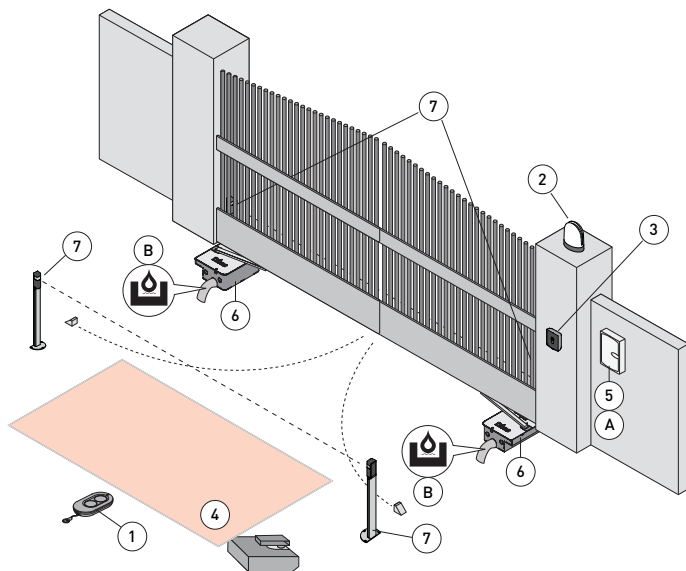

Ref.	Description	Cable
1	Transmitter	/
2	Flashing light (integrated into the flashing light) - coaxial	2 x 1,5 mm ² antenna 58 Ω (max 10 m)
3	Key selector switch Digital combination wireless keypad *only if an external power supply is used as an alternative to the battery	4 x 0,5 mm ²
4	CUBIC6 CUBIC6 with magnetic limit switches	4G x 1,5 mm ² 6G x 1,5 mm ²
5	Photocells	4 x 0,5 mm ²
6	Control panel	3G x 1,5 mm ²
A	Connect the power supply to a type-approved omnipolar switch, with a contact opening distance of at least 3 mm (not supplied). The connection to the mains must follow an independent path, separate from the connections to the control and safety devices	
B	Connect the drainage pipe to the foundation box.	



5. Examples applications

CUBIC6L - CUBIC6LG

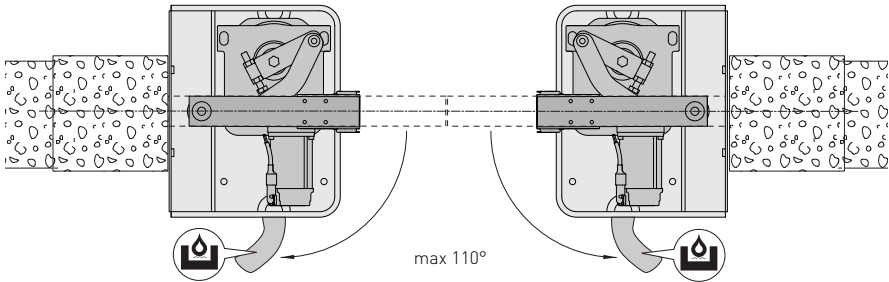

CUBIC6TC

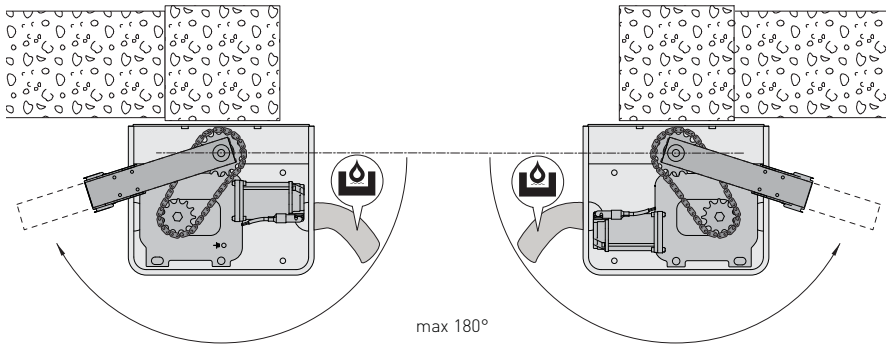

6. Installation

Unless otherwise specified, all measurements are expressed in millimetres (mm).

6.1 Preliminary checks

Check that the structure is sufficiently sturdy and that the hinge pivots are properly lubricated. Provide an opening and closing stop.

NOTE: if the gate wing is more than 2.5 m wide, an electric lock should be installed.

6.2 Foundation case installation

Install the foundation case as indicated in the relevant manual.



Connect the drainage pipe to the foundation box. If there is no suitable drainage system, suitable dispersion drainage must be provided. Comply with the IP67 rating of the gearmotor.

Incorrect drainage of the foundation box may damage the gearmotor and make the warranty void.

6.3 Lever mechanisms installation

Choose and install the lever mechanisms as indicated in the relevant manual.

6.4 Wing release installation

Choose and install the door release mechanisms as indicated in the relevant manual.

WARNING: to install the releases more easily, we advise you to position the gate at the centre of the foundation casing and remove the lid, in such a way as to have enough space for fixing the screws.

6.5 Geared motor installation

After installing the foundation casing, the respective lever and release mechanisms go before the installation of the gear motor as shown in the figure.

NOTE: the figure shows the motor installed on the right door wing.

Carefully clean the bottom of the foundation casing from dirt or cement to guarantee an even laying of the gearmotor.

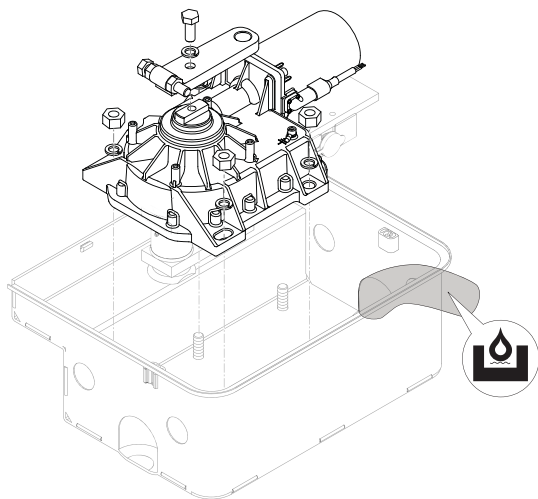

6.6 Installation with CUBIC6L-CUBIC6LG

Insert lever [A] on the gearmotor and position the mechanical stop [B] and [C] and adjust it, as shown in the figure.

NOTE: the figure shows the motor installed on the right door wing.

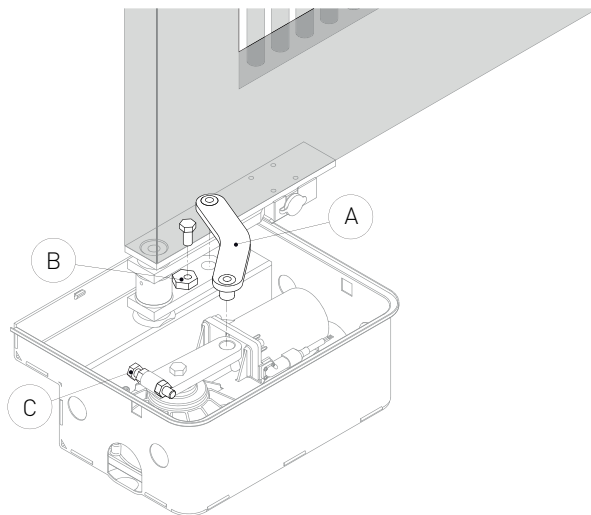

6.7 Installation with CUBIC6TC

Insert pinion [A] and join the two pinions by means of the chain [B], as shown in the figure.

Lubricate the chain and the lever mechanism as indicated in the figure.

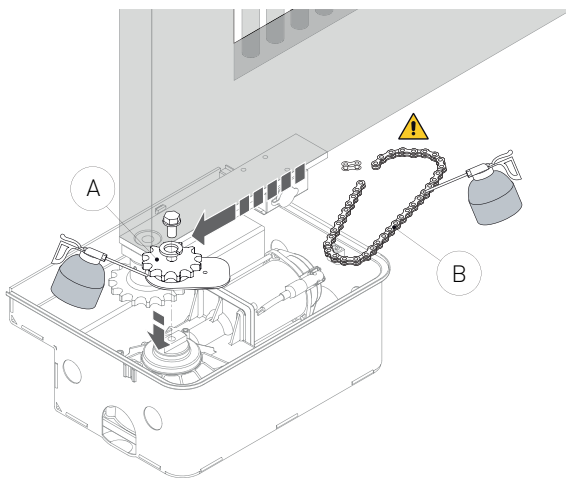

WARNING: fasten the motor to the foundation case after connecting the chain.

6.8 CUBIC6FM installation

It is possible to limit the travel of the wing by means of magnetic limit switches. Choose and install the magnetic limit switches as indicated in the relative manual. Make the electrical connections as shown in the control panel.

WARNING: the magnetic limit switches cannot interrupt the power supply to the motor.

7. Electrical connections

Before connecting the power supply, make sure the plate data correspond to that of the mains power supply.

An omnipolar disconnection switch with minimum contact gaps of 3 mm must be included in the mains supply.

Check that upstream of the electrical installation there is an adequate residual current circuit breaker and a suitable overcurrent cutout.



WARNING: the electrical connections for the extension of the motor cables must be made on the outside of the foundation casing in an appropriate junction box (not supplied).

In the CUBIC6 gearmotors, the blue wire corresponds to the common contact of the motor phases, and must be connected to the W or Z terminals of the control panel.

The CUBIC6 gearmotor can be connected to the LCA70 and LCA80 control panels.

The CUBIC6H and CUBIC6VH gearmotors can be connected to the LCU40H-HJ control panel.

The electrical connections and the start-up of the gearmotors are shown in the installation manuals of the LCA70, LCA80 and LCU40H-HJ control panels.

8. Routine maintenance plan

Perform the following operations and checks every 6 months according to intensity of use of the automation.

Without 230 V~ power supply and batteries if present:

- Lubricate the levers of the gearmotor.
- Lubricate the rotation pivot of the gate leaf.
- Lubricate the gate leaf hinges.
- Check the good conditions of the electric connection.
- Check that the fixing screws of the gearmotor are firmly tightened.



Clean the inside of the cases and check that drain is not clogged.

- Check the value of the capacity of the motor condenser.

Reconnect the 230 V~ power supply and batteries if present:

- Check the power adjustment.
- Check the good operation of all command and safety functions (photocells).
- Check the good operation of the release system.



NOTE: For spare parts, see the spares price list.

Operating instructions

General safety precautions for the user

 These precautions are an integral and essential part of the product and must be supplied to the user. Read them carefully since they contain important information on safe installation, use and maintenance. These instructions must be kept and forwarded to all possible future users of the system.

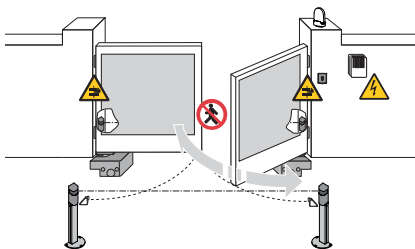

This product must only be used for the specific purpose for which it was designed. Any other use is to be considered improper and therefore dangerous.

The manufacturer cannot be held responsible for any damage caused by improper, incorrect or unreasonable use.

Avoid operating in the proximity of the hinges or moving mechanical parts. Do not enter within the operating range of the motorised door or gate while it is moving.

Do not obstruct the motion of the motorised door or gate, as this may cause a dangerous situation.

The motorised door or gate may be used by children over the age of 8 and by people with reduced physical, sensorial or mental abilities, or lack of experience or knowledge, as long as they are properly supervised or have been instructed in the safe use of the device and the relative hazards.

Do not allow children to play or stay within the operating range of the motorised door or gate.

Keep remote controls and/or any other command devices out of the reach of children, to avoid any accidental activation of the motorised door or gate.

In the event of a product fault or malfunction, turn off the power supply switch. Do not attempt to repair or intervene directly, and contact only qualified personnel.

Failure to comply with the above may cause a dangerous situation.

Any repair or technical intervention must be carried out by qualified personnel.

Cleaning and maintenance work must not be carried out by children unless they are supervised.

To ensure that the system works efficiently and correctly, the manufac-



turer's indications must be complied with and only qualified personnel must perform routine maintenance on the motorised door or gate.



In particular, regular checks are recommended in order to verify that the safety devices are operating correctly.
Check that the foundation boxes are clean and correctly drained.

All installation, maintenance and repair work must be documented and made available to the user.

Only lock and release the door wings when the motor is switched off. Do not enter within the operating range of the wing.

 To dispose of electrical and electronic equipment, batteries and storage cells correctly, users must take the product to special "recycling centres" provided by the municipal authorities for disposal according to the methods envisaged by current legislation.

Manual release instructions

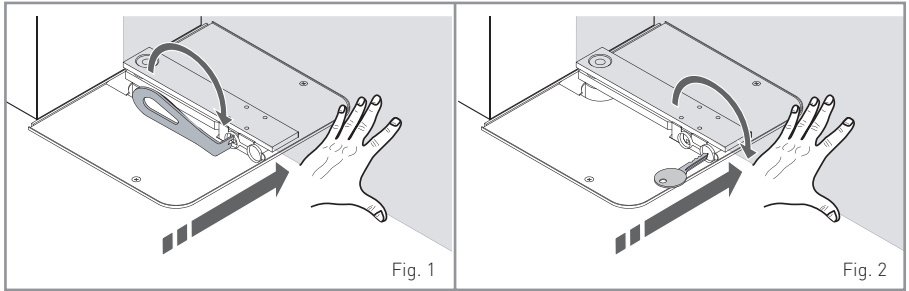

In the event of failure or if there is no voltage:

CUBIC6SBL: insert the lock release lever and rotate by 180° (fig.1). Release any electric lock. Manually open the gate.

CUBIC6SBD: insert the lock release key in the lock and rotate by 180° (fig.2). Release any electric lock. Manually open the gate.

To block the door wings again: rotate the lock release lever or key by 180°. Move the door wing manually until it is completely reattached.



WARNING: the door wing block and release operations must be performed with the motor idle.



For any problems and/or information, contact the Technical Service.

All the rights concerning this material are the exclusive property of ASSA ABLOY Entrance Systems AB. Although the contents of this publication have been drawn up with the greatest care, ASSA ABLOY Entrance Systems AB cannot be held responsible in any way for any damage caused by mistakes or omissions in this publication.

We reserve the right to make changes without prior notice.

Copying, scanning or changing in any way is expressly forbidden unless authorised in writing by ASSA ABLOY Entrance Systems AB.

 The crossed-out wheellie bin symbol indicates that the product should be disposed of separately from normal household waste. The product should be recycled in accordance with local environmental regulations for waste disposal. By separating a product marked with this symbol from household waste, you will help reduce the volume of waste sent to incinerators or land-fill and minimise any potential negative impact on human health and the environment.

